

Laparoscopy Catalog

WE DESIGN, MANUFACTURE & SELL THE TOOLS THE SURGEONS USE



Phone - +92-321-7131643
+92-300-9671821

Email- info@mzhenterprises.com

Web - mzhenterprises.com

Our Laparoscopic Instruments are hand assembled by our highly trained technicians to assure that each instrument is of the best quality and highest standards. For over 40 years MZH has served the Medical Community and has become a trusted name in high quality Laparoscopic Instrumentation at the most economical cost. Our products are assembled in Sialkot using the finest materials from our partners. With our extensive tip and handle selection we aim to please even the toughest customers. Our modular take apart line is set up so that you can interchange any of our handles with any of our inserts & shafts at any time.

OFFERED IN 3 STYLES:

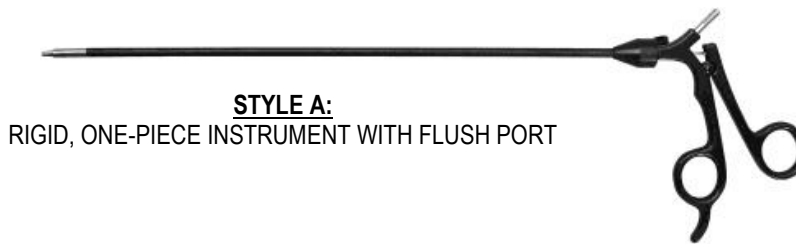

STYLE A:
RIGID, ONE-PIECE INSTRUMENT WITH FLUSH PORT



STYLE B:
ROTATABLE, ONE-PIECE INSTRUMENT WITH FLUSH PORT



STYLE C:
ROTATABLE, 3-PIECE SCREW-APART INSTRUMENT

Please Use The Example Below When Ordering The Elmed "Blue Monarch" Line Of Instrumentation:

<u>TIP & STYLE</u>	+	<u>HANDLE TYPE</u>	=	<u>COMPLETE INSTRUMENT</u>
52255-01B	+	TYPE 1	=	52255-01B1

This section features our “Blue Monarch” 5mm Rigid One-Piece Instrument (Style A) and our 5mm Rotatable One-Piece Instrument (Style B). Both have flush ports for easy cleaning and are available with any of our suggested handles & any of the handles pictured on Page 28.

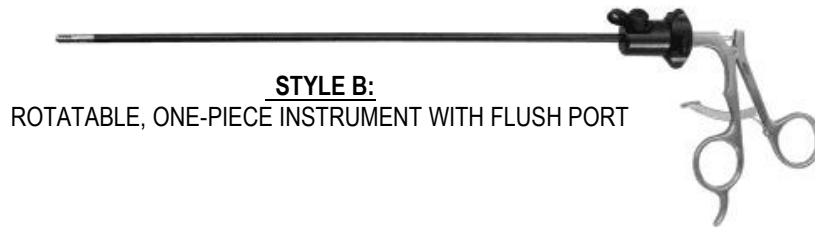
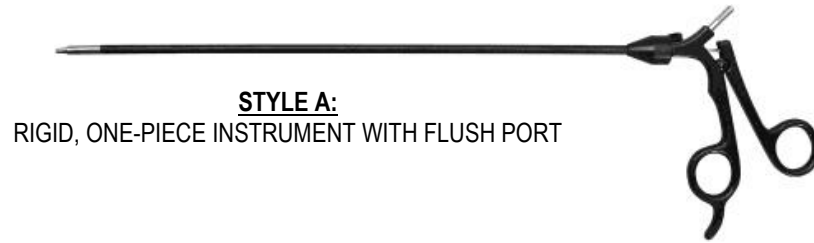

Please Use The Example Below When Ordering The Elmed “Blue Monarch” Line Of Instrumentation:

<u>TIP & STYLE</u>	+	<u>HANDLE TYPE</u>	=	<u>COMPLETE INSTRUMENT</u>
52255-01B	+	TYPE 1	=	52255-01B1















GRASPERS & DISSECTORS

STYLE A:
RIGID, ONE-PIECE INSTRUMENT WITH
FLUSH PORT

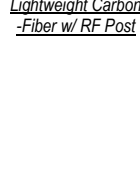

STYLE B:
ROTATABLE, ONE-PIECE INSTRUMENT
WITH FLUSH PORT



	<u>Length</u>	<u>Style A:</u>	<u>Style B:</u>	<u>Recommended</u>	<u>Optional</u>
 5MM Ø, MICRO REDDICK- OLSEN GRASPER/DISSECTOR	33 CM	52255-01A	52255-01B	 Type 1: Insulated Stainless Steel w/ RF Post	 Type 3: Non-Insulated Stainless Steel
	36 CM	52236-01A	52236-01B		
	45 CM	52155-01A	52155-01B		
	24 CM	52224-01A	52224-01B		
 5MM Ø, STANDARD GRASPER/DISSECTOR WITH SPOON	33 CM	52255-02A	52255-02B	 Type 7: Lightweight Carbon-Fiber w/ RF Post, Ratchet / Ratchet Defeating	 Type 9: Lightweight Carbon-Fiber w/ RF Post, w/ Large Finger Loops
	36 CM	52236-02A	52236-02B		
	45 CM	52155-02A	52155-02B		
	24 CM	52224-02A	52224-02B		
 5MM Ø, STANDARD GRASPER/DISSECTOR W/ SPOON, LONG 20 MM JAW	52255-01A	52255-52A	52255-52B	 Type 5: Lightweight Carbon -Fiber w/ RF Post	 Type 17: Lightweight Carbon -Fiber w/ RF Post
	52236-01A	52236-52A	52236-52B		
	52155-01A	52155-52A	52155-52B		
	52221-01A	52224-52A	52224-52B		
 5MM Ø, STANDARD GRASPER/DISSECTOR	33 CM	52255-03A	52255-03B	 Type 18: Carbon-Fiber w/ RF Post, Ratchet / Ratchet Defeating	
	36 CM	52236-03A	52236-03B		
	45 CM	52155-03A	52155-03B		
	24 CM	52224-03A	52224-03B		
 5MM Ø, BULLET-NOSE GRASPER/DISSECTOR WITH SPOON	33 CM	52255-04A	52255-04B		
	36 CM	52236-04A	52236-04B		
	45 CM	52155-04A	52155-04B		
	24 CM	52224-04A	52224-04B		
 5MM Ø, TAPERED DOLPHIN- NOSE GRASPER/DISSECTOR	33 CM	52255-05A	52255-05B		
	36 CM	52236-05A	52236-05B		
	45 CM	52155-05A	52155-05B		
	24 CM	52224-05A	52224-05B		
 5MM Ø, TAPERED DOLPHIN- NOSE GRASPER/DISSECTOR W/ SPOON	33 CM	52255-105A	52255-105B		
	36 CM	52236-105A	52236-105B		
	45 CM	52155-105A	52155-105B		
	24 CM	52224-105A	52224-105B		
 5MM Ø, MARYLAND GRASPER/DISSECTOR, 18MM LENGTH TIP	33 CM	52255-06A	52255-06B		
	36 CM	52236-06A	52236-06B		
	45 CM	52155-06A	52155-06B		
	24 CM	52224-06A	52224-06B		
 5MM Ø, TAPERED MARYLAND GRASPER/DISSECTOR, 18MM LENGTH TIP	33 CM	52255-99A	52255-99B		
	36 CM	52236-99A	52236-99B		
	45 CM	52155-99A	52155-99B		
	24 CM	52224-99A	52224-99B		
 5MM Ø, SHORT MARYLAND GRASPER/DISSECTOR, 15MM LENGTH TIP	33 CM	52255-91A	52255-91B		
	36 CM	52236-91A	52236-91B		
	45 CM	52155-91A	52155-91B		
	24 CM	52224-91A	52224-91B		

TIP & STYLE + HANDLE TYPE = COMPLETE INSTRUMENT
 52255-01B + TYPE 1 = 52255-01B1

GRASPERS & DISSECTORS

STYLE A:
RIGID, ONE-PIECE INSTRUMENT WITH
FLUSH PORT



STYLE B:
ROTATABLE, ONE-PIECE INSTRUMENT
WITH FLUSH PORT



	<u>Length</u>	<u>Style A:</u>	<u>Style B:</u>
5MM Ø, MIXTER GRASPER/ DISSECTOR RIGHT ANGLE (LONG)	33 CM	52255-07A	52255-07B
	36 CM	52236-07A	52236-07B
	45 CM	52155-07A	52155-07B
	24 CM	52224-07A	52224-07B



5MM Ø, MIXTER GRASPER/ DISSECTOR, SHORT RIGHT ANGLE	33 CM	52255-59A	52255-59B
	36 CM	52236-59A	52236-59B
	45 CM	52155-59A	52155-59B
	24 CM	52224-59A	52224-59B



5MM Ø, MIXTER GRASPER/ DISSECTOR 45 DEGREE ANGLE	33 CM	52255-08A	52255-08B
	36 CM	52236-08A	52236-08B
	45 CM	52155-08A	52155-08B
	24 CM	52224-08A	52224-08B



5MM Ø, DUCKBILL GRASPER/ DISSECTOR	33 CM	52255-09A	52255-09B
	36 CM	52236-09A	52236-09B
	45 CM	52155-09A	52155-09B
	24 CM	52224-09A	52224-09B



5MM Ø, NEEDLE-NOSE GRASPER/DISSECTOR	33 CM	52255-10A	52255-10B
	36 CM	52236-10A	52236-10B
	45 CM	52155-10A	52155-10B
	24 CM	52224-10A	52224-10B



5MM Ø, KELLY GRASPER/ DISSECTOR	33 CM	52255-11A	52255-11B
	36 CM	52236-11A	52236-11B
	45 CM	52155-11A	52155-11B
	24 CM	52224-11A	52224-11B



5MM Ø, LONG REACH, RIGHT ANGLE DISSECTOR, DBL- ACTION (REQUIRES LARGER CANNULA)	33 CM	52255-53A	52255-53B
	36 CM	52236-53A	52236-53B
	45 CM	52155-53A	52155-53B
	24 CM	52224-53A	52224-53B



5MM Ø, PETELIN DISSECTOR, 60 DEG. ANGLE LEFT, SINGLE-ACTION	33 CM	52255-12A	52255-12B
	36 CM	52236-12A	52236-12B
	45 CM	52155-12A	52155-12B
	24 CM	52224-12A	52224-12B



5MM Ø, PETELIN DISSECTOR, 30 DEG. ANGLE LEFT, SINGLE- ACTION	33 CM	52255-13A	52255-13B
	36 CM	52236-13A	52236-13B
	45 CM	52155-13A	52155-13B
	24 CM	52224-13A	52224-13B



5MM Ø, MICRO GRASPER/ DISSECTOR, FENESTRATED	33 CM	52255-14A	52255-14B
	36 CM	52236-14A	52236-14B
	45 CM	52155-14A	52155-14B
	24 CM	52224-14A	52224-14B

Recommended

Optional



Type 1:
Insulated Stainless
Steel w/ RF Post



Type 3:
Non-Insulated
Stainless Steel

OR



Type 7:
Lightweight
Carbon-Fiber w/
RF Post, Ratchet /
Ratchet Defeating

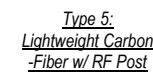

Type 5:
Lightweight Carbon
-Fiber w/ RF Post



Type 9:
Lightweight
Carbon-Fiber w/
RF Post, w/ Large
Finger Loops

OR



Type 17:
Lightweight Carbon
-Fiber w/ RF Post



Type 18:
Carbon-Fiber w/
RF Post, Ratchet /
Ratchet Defeating

TIP & STYLE + HANDLE TYPE = COMPLETE INSTRUMENT
52255-01B + TYPE 1 = 52255-01B1

GRASPERS & DISSECTORS

STYLE A:
RIGID, ONE-PIECE INSTRUMENT WITH
FLUSH PORT



STYLE B:
ROTATABLE, ONE-PIECE INSTRUMENT
WITH FLUSH PORT



	<u>Length</u>	<u>Style A:</u>	<u>Style B:</u>
5MM Ø, COBRA GRASPER, DOUBLE-ACTION	33 CM	52255-15A	52255-15B
	36 CM	52236-15A	52236-15B
	45 CM	52155-15A	52155-15B
	24 CM	52224-15A	52224-15B
5MM Ø, BABCOCK GRASPER, FENESTRATED TIP	33 CM	52255-16A	52255-16B
	36 CM	52236-16A	52236-16B
	45 CM	52155-16A	52155-16B
	24 CM	52224-16A	52224-16B
5MM Ø, BABCOCK GRASPER, AXIS STYLE, FENESTRATED TIP	33 CM	52255-116A	52255-116B
	36 CM	52236-116A	52236-116B
	45 CM	52155-116A	52155-116B
	24 CM	52224-116A	52224-116B
5MM Ø, BABCOCK GRASPER- SHORT: DELICATE APPLICATION	33 CM	52255-17A	52255-17B
	36 CM	52236-17A	52236-17B
	45 CM	52155-17A	52155-17B
	24 CM	52224-17A	52224-17B
5MM Ø, ALLIS GRASPER, SHORT VERSION, SINGLE ACTION	33 CM	52255-18A	52255-18B
	36 CM	52236-18A	52236-18B
	45 CM	52155-18A	52155-18B
	24 CM	52224-18A	52224-18B
5MM Ø, ALLIS GRASPER, SHORT VERSION, 3 X 4 TEETH, SERRATED, DOUBLE- ACTION	33 CM	52255-19A	52255-19B
	36 CM	52236-19A	52236-19B
	45 CM	52155-19A	52155-19B
	24 CM	52224-19A	52224-19B
5MM Ø, ATRAUMATIC ALLIS GRASPER, SHORT VERSION, SERRATED W/ DOUBLE ROW OF TEETH, DOUBLE-ACTION	33 CM	52255-119A	52255-119B
	36 CM	52236-119A	52236-119B
	45 CM	52155-119A	52155-119B
	24 CM	52224-119A	52224-119B
5MM Ø, ATRAUMATIC ALLIS GRASPER, LONG VERSION, SERRATED W/ DOUBLE ROW OF TEETH, DOUBLE-ACTION	33 CM	52255-219A	52255-219B
	36 CM	52236-219A	52236-219B
	45 CM	52155-219A	52155-219B
	24 CM	52224-219A	52224-219B
5MM Ø, ALLIS GRASPER, MEDIUM VERSION, (WECK STYLE)	33 CM	52255-20A	52255-20B
	36 CM	52236-20A	52236-20B
	45 CM	52155-20A	52155-20B
	24 CM	52224-20A	52224-20B
5MM Ø, ALLIS GRASPER, STANDARD VERSION	33 CM	52255-21A	52255-21B
	36 CM	52236-21A	52236-21B
	45 CM	52155-21A	52155-21B
	24 CM	52224-21A	52224-21B

Recommended

Optional



Type 2:
Insulated Stainless
Steel w/ RF Post &
Ratchet

Type 4:
Non-Insulated
Stainless Steel w/
Ratchet

OR



Type 6:
Lightweight Carbon
-Fiber w/ RF Post
& Ratchet

Type 7:
Lightweight
Carbon-Fiber w/
RF Post, Ratchet /
Ratchet Defeating

OR



Type 9:
Lightweight
Carbon-Fiber w/
RF Post, Ratchet /
Ratchet Defeating
w/ Large Finger
Loops

Type 8:
Lightweight
Carbon-Fiber w/
RF Post, French
On/Off Ratchet



Type 18:
Carbon-Fiber w/
RF Post, Ratchet /
Ratchet Defeating

TIP & STYLE + HANDLE TYPE = COMPLETE INSTRUMENT
52255-01B + TYPE 1 = 52255-01B1















GRASPERS & DISSECTORS

STYLE A:
RIGID, ONE-PIECE INSTRUMENT WITH FLUSH PORT



STYLE B:
ROTATABLE, ONE-PIECE INSTRUMENT WITH FLUSH PORT



	<u>Length</u>	<u>Style A:</u>	<u>Style B:</u>	<u>Recommended</u>	<u>Optional</u>
5MM Ø, TC ALLIS, STANDARD VERSION	33 CM	52255-57A	52255-57B		
	36 CM	52236-57A	52236-57B		
	45 CM	52155-57A	52155-57B		
	24 CM	52224-57A	52224-57B		
5MM Ø, DEBAKEY GRASPER, 20 MM JAW LENGTH	33 CM	52255-22A	52255-22B		<i>Type 4: Non-Insulated Stainless Steel w/ Ratchet</i>
	36 CM	52236-22A	52236-22B		
	45 CM	52155-22A	52155-22B		
	24 CM	52224-22A	52224-22B		
5MM Ø, DEBAKEY GRASPER, 40 MM JAW LENGTH	33 CM	52255-23A	52255-23B		
	36 CM	52236-23A	52236-23B		
	45 CM	52155-23A	52155-23B		
	24 CM	52224-23A	52224-23B		
5MM Ø, HUNTER/ FENESTRATED DEBAKEY GRASPER, 20 MM JAW LENGTH	33 CM	52255-58A	52255-58B		
	36 CM	52236-58A	52236-58B		
	45 CM	52155-58A	52155-58B		
	24 CM	52224-58A	52224-58B		
5MM Ø, HUNTER/ FENESTRATED DEBAKEY GRASPER, 40 MM JAW LENGTH	33 CM	52255-159A	52255-159B		<i>Type 7: Lightweight Carbon-Fiber w/ RF Post, Ratchet / Ratchet Defeating</i>
	36 CM	52236-159A	52236-159B		
	45 CM	52155-159A	52155-159B		
	24 CM	52224-159A	52224-159B		
5MM Ø, HUNTER/ FENESTRATED DEBAKEY GRASPER, 60 MM JAW LENGTH	33 CM	52255-160A	52255-160B		
	36 CM	52236-160A	52236-160B		
	45 CM	52155-160A	52155-160B		
	24 CM	52224-160A	52224-160B		
5MM Ø, DEBAKEY CURVED GRASPER, w/ ATRAUMATIC TEETH, DOUBLE-ACTION	33 CM	52255-46A	52255-46B		<i>Type 8: Lightweight Carbon-Fiber w/ RF Post, French On/Off Ratchet</i>
	36 CM	52236-46A	52236-46B		
	45 CM	52155-46A	52155-46B		
	24 CM	52224-46A	52224-46B		
5MM Ø, GLASSMAN ATRAUMATIC GRASPER	33 CM	52255-24A	52255-24B		
	36 CM	52236-24A	52236-24B		
	45 CM	52155-24A	52155-24B		
	24 CM	52224-24A	52224-24B		
5MM Ø, ATRAUMATIC GRASPER, CROSS SERRATED	33 CM	52255-25A	52255-25B		<i>Type 18: Carbon-Fiber w/ RF Post, Ratchet / Ratchet Defeating</i>
	36 CM	52236-25A	52236-25B		
	45 CM	52155-25A	52155-25B		
	24 CM	52224-25A	52224-25B		
5MM Ø, DOUBLE CUP FUNDUS MAXI GRASPER	33 CM	52255-26A	52255-26B		<i>Type 18: Carbon-Fiber w/ RF Post, Ratchet / Ratchet Defeating</i>
	36 CM	52236-26A	52236-26B		
	45 CM	52155-26A	52155-26B		
	24 CM	52224-26A	52224-26B		

TIP & STYLE + HANDLE TYPE = COMPLETE INSTRUMENT
52255-01B + TYPE 1 = 52255-01B1

GRASPERS & DISSECTORS

STYLE A:
RIGID, ONE-PIECE INSTRUMENT WITH
FLUSH PORT



ROTARY



	<u>Length</u>	<u>Style A:</u>	<u>Style B:</u>
5MM Ø, "WINER" STYLE FUNDUS MAXI GRASPER	33 CM	52255-326A	52255-326B
	36 CM	52236-326A	52236-326B
	45 CM	52155-326A	52155-326B
	24 CM	52224-326A	52224-326B
5MM Ø, "MCKERNAN" STYLE FUNDUS MAXI GRASPER	33 CM	52255-126A	52255-126B
	36 CM	52236-126A	52236-126B
	45 CM	52155-126A	52155-126B
	24 CM	52224-126A	52224-126B
5MM Ø, DOUBLE CUP FENESTRATED FUNDUS MAXI GRASPER	33 CM	52255-226A	52255-226B
	36 CM	52236-226A	52236-226B
	45 CM	52155-226A	52155-226B
	24 CM	52224-226A	52224-226B
5MM Ø, ENDO CLINCH FENESTRATED GRASPER	33 CM	52255-27A	52255-27B
	36 CM	52236-27A	52236-27B
	45 CM	52155-27A	52155-27B
	24 CM	52224-27A	52224-27B
5MM Ø, RETRO FACING RAT-TOOTH GRASPER w/ ATRAUMATIC CUP	33 CM	52255-28A	52255-28B
	36 CM	52236-28A	52236-28B
	45 CM	52155-28A	52155-28B
	24 CM	52224-28A	52224-28B
5MM Ø, ALLIGATOR GRASPER, 10MM JAW, RETRO FACING TEETH, DBL-ACTION	33 CM	52255-29A	52255-29B
	36 CM	52236-29A	52236-29B
	45 CM	52155-29A	52155-29B
	24 CM	52224-29A	52224-29B
5MM Ø, ALLIGATOR GRASPER, 20MM JAW, , RETRO FACING TEETH, DBL-ACTION	33 CM	52255-129A	52255-129B
	36 CM	52236-129A	52236-129B
	45 CM	52155-129A	52155-129B
	24 CM	52224-129A	52224-129B
5MM Ø, ALLIGATOR GRASPER, RETRO FACING TEETH, SINGLE-ACTION	33 CM	52255-30A	52255-30B
	36 CM	52236-30A	52236-30B
	45 CM	52155-30A	52155-30B
	24 CM	52224-30A	52224-30B
5MM Ø, CUP SHAPED GRASPER WITH RETRO FACING TEETH, DBL-ACTION	33 CM	52255-58A	52255-58B
	36 CM	52236-58A	52236-58B
	45 CM	52155-58A	52155-58B
	24 CM	52224-58A	52224-58B
5MM Ø, WAVE GRASPER, LONG BEVELED EDGE JAW, DBL-ACTION	33 CM	52255-32A	52255-32B
	36 CM	52236-32A	52236-32B
	45 CM	52155-32A	52155-32B
	24 CM	52224-32A	52224-32B

Recommended

Optional

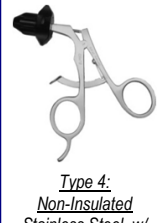

Type 2:
Insulated Stainless
Steel w/ RF Post &
Ratchet

Type 4:
Non-Insulated
Stainless Steel w/
Ratchet

OR



Type 7:
Lightweight
Carbon-Fiber w/
RF Post, Ratchet /
Ratchet Defeating

Type 6:
Lightweight Carbon
-Fiber w/ RF Post
& Ratchet



OR



Type 8:
Lightweight
Carbon-Fiber w/
RF Post, French
On/Off Ratchet

Type 9:
Lightweight
Carbon-Fiber w/
RF Post, Ratchet /
Ratchet Defeating
w/ Large Finger
Loops



Type 18:
Carbon-Fiber w/
RF Post, Ratchet /
Ratchet Defeating

TIP & STYLE + HANDLE TYPE = COMPLETE INSTRUMENT
52255-01B + TYPE 1 = 52255-01B1

GRASPERS & DISSECTORS

STYLE A:
RIGID, ONE-PIECE INSTRUMENT WITH FLUSH PORT



STYLE B:
ROTATABLE, ONE-PIECE INSTRUMENT WITH FLUSH PORT



	<u>Length</u>	<u>Style A:</u>	<u>Style B:</u>
5MM Ø, WAVE GRASPER, LONG BEVELED EDGE JAW, SINGLE ACTION	33 CM	52255-33A	52255-33B
	36 CM	52236-33A	52236-33B
	45 CM	52155-33A	52155-33B
	24 CM	52224-33A	52224-33B
5MM Ø, CLAW GRASPER, 2 X 3 TEETH, SINGLE-ACTION	33 CM	52255-36A	52255-36B
	36 CM	52236-36A	52236-36B
	45 CM	52155-36A	52155-36B
	24 CM	52224-36A	52224-36B
5MM Ø, CLAW GRASPER, 2 X 3 TEETH, W/ EXTRA ROW OF TEETH, DOUBLE-ACTION	33 CM	52255-136A	52255-136B
	36 CM	52236-136A	52236-136B
	45 CM	52155-136A	52155-136B
	24 CM	52224-136A	52224-136B
5MM Ø, RETRACTION GRASPER, LONG RIDGED JAWS, 2 X 3 ATRAUMATIC TEETH, DOUBLE-ACTION	33 CM	52255-34A	52255-34B
	36 CM	52236-34A	52236-34B
	45 CM	52155-34A	52155-34B
	24 CM	52224-34A	52224-34B
5MM Ø, RETRACTION GRASPER, LONG RIDGED JAWS, 2 X 3 ATRAUMATIC TEETH, SINGLE-ACTION	33 CM	52255-35A	52255-35B
	36 CM	52236-35A	52236-35B
	45 CM	52155-35A	52155-35B
	24 CM	52224-35A	52224-35B
5MM Ø, RETRACTION GRASPER, 2 X 3 ATRAUMATIC TEETH, DOUBLE-ACTION (JARIT STYLE)	33 CM	52255-134A	52255-134B
	36 CM	52236-134A	52236-134B
	45 CM	52155-134A	52155-134B
	24 CM	52224-134A	52224-134B
5MM Ø, RETRACTION GRASPER, 2 X 3 ATRAUMATIC TEETH, SINGLE-ACTION (JARIT STYLE)	33 CM	52255-135A	52255-135B
	36 CM	52236-135A	52236-135B
	45 CM	52155-135A	52155-135B
	24 CM	52224-135A	52224-135B
5MM Ø, ATRAUMATIC FENESTRATED GRASPER, CURVED, 16 MM DBL-ACTION JAW	33 CM	52255-37A	52255-37B
	36 CM	52236-37A	52236-37B
	45 CM	52155-37A	52155-37B
	24 CM	52224-37A	52224-37B
5MM Ø, FENESTRATED GRASPER, 16 MM DBL-ACTION JAW	33 CM	52255-38A	52255-38B
	36 CM	52236-38A	52236-38B
	45 CM	52155-38A	52155-38B
	24 CM	52224-38A	52224-38B
5MM Ø, FENESTRATED GRASPER, 20 MM DBL-ACTION JAW	33 CM	52255-39A	52255-39B
	36 CM	52236-39A	52236-39B
	45 CM	52155-39A	52155-39B
	24 CM	52224-39A	52224-39B

Recommended

Optional



*Type 2:
Insulated Stainless Steel w/ RF Post & Ratchet*

*Type 4:
Non-Insulated Stainless Steel w/ Ratchet*

OR



*Type 7:
Lightweight Carbon-Fiber w/ RF Post, Ratchet / Ratchet Defeating*

*Type 6:
Lightweight Carbon-Fiber w/ RF Post & Ratchet*



OR



*Type 8:
Lightweight Carbon-Fiber w/ RF Post, French On/Off Ratchet*

*Type 9:
Lightweight Carbon-Fiber w/ RF Post, Ratchet / Ratchet Defeating w/ Large Finger Loops*



*Type 18:
Carbon-Fiber w/ RF Post, Ratchet / Ratchet Defeating*

TIP & STYLE + HANDLE TYPE = COMPLETE INSTRUMENT
52255-01B + TYPE 1 = 52255-01B1

GRASPERS & DISSECTORS

STYLE A:
RIGID, ONE-PIECE INSTRUMENT WITH FLUSH PORT



STYLE B:
ROTATABLE, ONE-PIECE INSTRUMENT WITH FLUSH PORT



	<u>Length</u>	<u>Style A:</u>	<u>Style B:</u>
5MM Ø, FENESTRATED GRASPER, 40 MM DBL-ACTION JAW	33 CM	52255-40A	52255-40B
	36 CM	52236-40A	52236-40B
	45 CM	52155-40A	52155-40B
	24 CM	52224-40A	52224-40B
5MM Ø, JOHAN FENESTRATED GRASPER, 22 MM SINGLE-ACTION FLAT JAWS	33 CM	52255-41A	52255-41B
	36 CM	52236-41A	52236-41B
	45 CM	52155-41A	52155-41B
	24 CM	52224-41A	52224-41B
5MM Ø, JOHAN FENESTRATED GRASPER, 45 MM SGL-ACTION FLAT JAWS	33 CM	52255-42A	52255-42B
	36 CM	52236-42A	52236-42B
	45 CM	52155-42A	52155-42B
	24 CM	52224-42A	52224-42B
5MM Ø, KOCHER GRASPER, 1 X 2 TEETH, SINGLE-ACTION FLAT JAWS	33 CM	52255-43A	52255-43B
	36 CM	52236-43A	52236-43B
	45 CM	52155-43A	52155-43B
	24 CM	52224-43A	52224-43B
5MM Ø, KOCHER GRASPER, 1 X 2 TEETH, DOUBLE-ACTION (WECK TYPE)	33 CM	52255-44A	52255-44B
	36 CM	52236-44A	52236-44B
	45 CM	52155-44A	52155-44B
	24 CM	52224-44A	52224-44B
5MM Ø, SCHROEDER TENACULUM GRASPER, SINGLE TEETH	33 CM	52255-45A	52255-45B
	36 CM	52236-45A	52236-45B
	45 CM	52155-45A	52155-45B
	24 CM	52224-45A	52224-45B
5MM Ø, SCHROEDER TENACULUM GRASPER, SINGLE TEETH w/ EXTRA GUIDE TOOTH	33 CM	52255-94A	52255-94B
	36 CM	52236-94A	52236-94B
	45 CM	52155-94A	52155-94B
	24 CM	52224-94A	52224-94B
5MM Ø, BLUNT ATRAUMATIC GRASPING FORCEPS, DOUBLE-ACTION	33 CM	52255-47A	52255-47B
	36 CM	52236-47A	52236-47B
	45 CM	52155-47A	52155-47B
	24 CM	52224-47A	52224-47B
5MM Ø, BLUNT ATRAUMATIC GRASPER W/ CROSS-SERRATED TIPS, DBL-ACTION	33 CM	52255-56A	52255-56B
	36 CM	52236-56A	52236-56B
	45 CM	52155-56A	52155-56B
	24 CM	52224-56A	52224-56B
5MM Ø, BULLET NOSE GRASPER/DISSECTOR, TC, MICRO DIAMOND JAW PATTERN DOUBLE-ACTION	33 CM	52255-48A	52255-48B
	36 CM	52236-48A	52236-48B
	45 CM	52155-48A	52155-48B
	24 CM	52224-48A	52224-48B

<u>Recommended</u>	<u>Optional</u>
	
<i>Type 2: Insulated Stainless Steel w/ RF Post & Ratchet</i>	<i>Type 4: Non-Insulated Stainless Steel w/ Ratchet</i>
OR	
	<i>Type 7: Lightweight Carbon-Fiber w/ RF Post, Ratchet / Ratchet Defeating</i>
<i>Type 6: Lightweight Carbon-Fiber w/ RF Post & Ratchet</i>	
OR	<i>Type 8: Lightweight Carbon-Fiber w/ RF Post, French On/Off Ratchet</i>
	
<i>Type 9: Lightweight Carbon-Fiber w/ RF Post, Ratchet / Ratchet Defeating w/ Large Finger Loops</i>	<i>Type 18: Carbon-Fiber w/ RF Post, Ratchet / Ratchet Defeating</i>

TIP & STYLE + HANDLE TYPE = COMPLETE INSTRUMENT
 52255-01B + TYPE 1 = 52255-01B1















GRASPERS & DISSECTORS

STYLE A:
RIGID, ONE-PIECE INSTRUMENT WITH FLUSH PORT



STYLE B:
ROTATABLE, ONE-PIECE INSTRUMENT WITH FLUSH PORT



	<u>Length</u>	<u>Style A:</u>	<u>Style B:</u>	<u>Recommended</u>	<u>Optional</u>
 5MM Ø, BULLET NOSE GRASPER/DISSECTOR, TC, CROSS DIAMOND JAW PATTERN DOUBLE-ACTION	33 CM	52255-49A	52255-49B	 Type 2: <i>Insulated Stainless Steel w/ RF Post & Ratchet</i>	 Type 4: <i>Non-Insulated Stainless Steel w/ Ratchet</i>
	36 CM	52236-49A	52236-49B		
	45 CM	52155-49A	52155-49B		
	24 CM	52224-49A	52224-49B		
 5MM Ø, LONG TAPERED GRASPER W/ ATRAUMATIC TEETH, DBL-ACTION	33 CM	52255-51A	52255-51B	 Type 7: <i>Lightweight Carbon-Fiber w/ RF Post, Ratchet / Ratchet Defeating</i>	
	36 CM	52236-51A	52236-51B		
	45 CM	52155-51A	52155-51B		
	24 CM	52224-51A	52224-51B		
 5MM Ø, WAVE GRASPER, POINTED, SINGLE-ACTION	33 CM	52255-54A	52255-54B	OR	
	36 CM	52236-54A	52236-54B		
	45 CM	52155-54A	52155-54B		
	24 CM	52224-54A	52224-54B		
 5MM Ø, WAVE GRASPER, BLUNT, SINGLE-ACTION	33 CM	52255-55A	52255-55B	 Type 6: <i>Lightweight Carbon-Fiber w/ RF Post & Ratchet</i>	
	36 CM	52236-55A	52236-55B		
	45 CM	52155-55A	52155-55B		
	24 CM	52224-55A	52224-55B		
 5MM Ø, "DAVOL" TYPE, ATRAUMATIC GRASPER, SCOOPED-OUT JAW & GENTLY MASHING TEETH	33 CM	52255-90A	52255-90B	OR	
	36 CM	52236-90A	52236-90B		
	45 CM	52155-90A	52155-90B		
	24 CM	52224-90A	52224-90B		
 5MM Ø, "ACCESS" TYPE, FENESTRATED GRASPER, 20MM JAW W/ AGGRESSIVE TEETH FOR POSITIVE EXTRA STRONG TISSUE HOLDING	33 CM	52255-91A	52255-91B	 Type 8: <i>Lightweight Carbon-Fiber w/ RF Post, French On/Off Ratchet</i>	
	36 CM	52236-91A	52236-91B		
	45 CM	52155-91A	52155-91B		
	24 CM	52224-91A	52224-91B		
 5MM Ø, "SOFT TOUCH" GRASPER, 22 MM JAW, ATRAUMATIC TEFLON INSERTS FOR THE LIGHT MINIMUM TISSUE TRAUMA TOUCH YET POSITIVE HOLDING	33 CM	52255-144A	52255-144B	 Type 9: <i>Lightweight Carbon-Fiber w/ RF Post, Ratchet / Ratchet Defeating w/ Large Finger Loops</i>	
	36 CM	52236-144A	52236-144B		
	45 CM	52155-144A	52155-144B		
	24 CM	52224-144A	52224-144B		
 5MM Ø, "SOFT TOUCH" GRASPER, 40 MM JAW, ATRAUMATIC TEFLON INSERTS FOR THE LIGHT MINIMUM TISSUE TRAUMA TOUCH YET POSITIVE HOLDING	33 CM	52255-145A	52255-145B	 Type 18: <i>Carbon-Fiber w/ RF Post, Ratchet / Ratchet Defeating</i>	
	36 CM	52236-145A	52236-145B		
	45 CM	52155-145A	52155-145B		
	24 CM	52224-145A	52224-145B		

TIP & STYLE + **HANDLE TYPE** = **COMPLETE INSTRUMENT**
 52255-01B + TYPE 1 = 52255-01B1































FORCEPS & SCISSORS

STYLE A:
RIGID, ONE-PIECE INSTRUMENT WITH FLUSH PORT



STYLE B:
ROTATABLE, ONE-PIECE INSTRUMENT WITH FLUSH PORT



	<u>Length</u>	<u>Style A:</u>	<u>Style B:</u>	<u>Recommended</u>	<u>Optional</u>
 5MM Ø, HOOK SCISSORS, SINGLE-ACTION	33 CM	52255-60A	52255-60B	 Type 1: <u>Insulated Stainless Steel w/ RF Post</u>	 Type 3: <u>Non-Insulated Stainless Steel</u>
	36 CM	52236-60A	52236-60B		
	45 CM	52155-60A	52155-60B		
	24 CM	52224-60A	52224-60B		
 5MM Ø, MICRO TIP SCISSORS, STRAIGHT, SINGLE-ACTION	33 CM	52255-61A	52255-61B	 Type 1: <u>Insulated Stainless Steel w/ RF Post</u>	 Type 7: <u>Lightweight Carbon-Fiber w/ RF Post, Ratchet / Ratchet Defeating</u>
	36 CM	52236-61A	52236-61B		
	45 CM	52155-61A	52155-61B		
	24 CM	52224-61A	52224-61B		
 5MM Ø, MICRO TIP SCISSORS, CURVED, SINGLE-ACTION	33 CM	52255-62A	52255-62B	<p style="text-align: center;">OR</p>  Type 5: <u>Lightweight Carbon-Fiber w/ RF Post</u>	 Type 9: <u>Lightweight Carbon-Fiber w/ RF Post, w/ Large Finger Loops</u>
	36 CM	52236-62A	52236-62B		
	45 CM	52155-62A	52155-62B		
	24 CM	52224-62A	52224-62B		
 5MM Ø, METZENBAUM SCISSORS, STRAIGHT, LONG BLADE (20MM TIP)	33 CM	52255-63A	52255-63B	<p style="text-align: center;">OR</p>  Type 17: <u>Lightweight Carbon-Fiber w/ RF Post</u>	 Type 18: <u>Carbon-Fiber w/ RF Post, Ratchet / Ratchet Defeating</u>
	36 CM	52236-63A	52236-63B		
	45 CM	52155-63A	52155-63B		
	24 CM	52224-63A	52224-62B		
 5MM Ø, METZENBAUM SCISSORS, STRAIGHT, SHORT BLADE (12MM TIP)	33 CM	52255-64A	52255-64B	<p style="text-align: center;">OR</p>  Type 17: <u>Lightweight Carbon-Fiber w/ RF Post</u>	 Type 18: <u>Carbon-Fiber w/ RF Post, Ratchet / Ratchet Defeating</u>
	36 CM	52236-64A	52236-64B		
	45 CM	52155-64A	52155-64B		
	24 CM	52224-64A	52224-64B		
 5MM Ø, METZENBAUM SCISSORS, CURVED, LONG BLADE (18MM TIP)	33 CM	52255-65A	52255-65B	<p style="text-align: center;">OR</p>  Type 17: <u>Lightweight Carbon-Fiber w/ RF Post</u>	 Type 18: <u>Carbon-Fiber w/ RF Post, Ratchet / Ratchet Defeating</u>
	36 CM	52236-65A	52236-65B		
	45 CM	52155-65A	52155-65B		
	24 CM	52224-65A	52224-65B		
 5MM Ø, METZENBAUM SCISSORS, HARDENED STEEL, CURVED BLADE (16MM TIP)	33 CM	52255-66A	52255-66B	<p style="text-align: center;">OR</p>  Type 17: <u>Lightweight Carbon-Fiber w/ RF Post</u>	 Type 18: <u>Carbon-Fiber w/ RF Post, Ratchet / Ratchet Defeating</u>
	36 CM	52236-66A	52236-66B		
	45 CM	52155-66A	52155-66B		
	24 CM	52224-66A	52224-66B		
 5MM Ø, METZENBAUM SCISSORS, CURVED, SHORT BLADE (11MM TIP)	33 CM	52255-166A	52255-166B	<p style="text-align: center;">OR</p>  Type 17: <u>Lightweight Carbon-Fiber w/ RF Post</u>	 Type 18: <u>Carbon-Fiber w/ RF Post, Ratchet / Ratchet Defeating</u>
	36 CM	52236-166A	52236-166B		
	45 CM	52155-166A	52155-166B		
	24 CM	52224-166A	52224-166B		
 5MM Ø, PERITONEAL SCISSORS, SINGLE-ACTION	33 CM	52255-67A	52255-67B	<p style="text-align: center;">OR</p>  Type 17: <u>Lightweight Carbon-Fiber w/ RF Post</u>	 Type 18: <u>Carbon-Fiber w/ RF Post, Ratchet / Ratchet Defeating</u>
	36 CM	52236-67A	52236-67B		
	45 CM	52155-67A	52155-67B		
	24 CM	52224-67A	52224-67B		
 5MM Ø, HOOK SCISSORS, TS, EXTRA HARD STEEL	33 CM	52255-76A	52255-76B	<p style="text-align: center;">OR</p>  Type 17: <u>Lightweight Carbon-Fiber w/ RF Post</u>	 Type 18: <u>Carbon-Fiber w/ RF Post, Ratchet / Ratchet Defeating</u>
	36 CM	52236-76A	52236-76B		
	45 CM	52155-76A	52155-76B		
	24 CM	52224-76A	52224-76B		

TIP & STYLE + HANDLE TYPE = COMPLETE INSTRUMENT
 52255-01B + TYPE 1 = 52255-01B1



























FORCEPS & SCISSORS

STYLE A:
RIGID, ONE-PIECE INSTRUMENT WITH
FLUSH PORT



STYLE B:
ROTATABLE, ONE-PIECE INSTRUMENT
WITH FLUSH PORT



	<u>Length</u>	<u>Style A:</u>	<u>Style B:</u>	<u>Recommended</u>	<u>Optional</u>
 5MM Ø, PERITONEAL SCISSORS, TS, EXTRA HARD STEEL, SINGLE-ACTION	33 CM	52255-77A	52255-77B	 <i>Type 1: Insulated Stainless Steel w/ RF Post</i>	 <i>Type 3: Non-Insulated Stainless Steel</i>
	36 CM	52236-77A	52236-77B		
	45 CM	52155-77A	52155-77B		
	24 CM	52224-77A	52224-77B		
 5MM Ø, PERITONEAL SCISSORS, TS, EXTRA HARD STEEL, DOUBLE-ACTION	33 CM	52255-78A	52255-78B	 <i>Type 7: Lightweight Carbon-Fiber w/ RF Post, Ratchet / Ratchet Defeating</i>	 <i>Type 9: Lightweight Carbon-Fiber w/ RF Post, w/ Large Finger Loops</i>
	36 CM	52236-78A	52236-78B		
	45 CM	52155-78A	52155-78B		
	24 CM	52224-78A	52224-78B		
 5MM Ø, BIOPSY SPOON FORCEPS W/ TOOTH, (SEMM-TYPE) SINGLE-ACTION	33 CM	52255-79A	52255-79B	 <i>Type 5: Lightweight Carbon -Fiber w/ RF Post</i>	 <i>Type 17: Lightweight Carbon -Fiber w/ RF Post</i>
	36 CM	52236-79A	52236-79B		
	45 CM	52155-79A	52155-79B		
	24 CM	52224-79A	52224-79B		
 5MM Ø, BIOPSY SPOON FORCEPS, SINGLE-ACTION	33 CM	52255-69A	52255-69B	 <i>Type 18: Carbon-Fiber w/ RF Post, Ratchet / Ratchet Defeating</i>	 <i>Type 18: Carbon-Fiber w/ RF Post, Ratchet / Ratchet Defeating</i>
	36 CM	52236-69A	52236-69B		
	45 CM	52155-69A	52155-69B		
	24 CM	52224-69A	52224-69B		
 5MM Ø, BIOPSY SPOON FORCEPS, DOUBLE-ACTION	33 CM	52255-70A	52255-70B	 <i>Type 17: Lightweight Carbon -Fiber w/ RF Post</i>	 <i>Type 18: Carbon-Fiber w/ RF Post, Ratchet / Ratchet Defeating</i>
	36 CM	52236-70A	52236-70B		
	45 CM	52155-70A	52155-70B		
	24 CM	52224-70A	52224-70B		
 5MM Ø, BIOPSY SPOON FORCEPS, W/ TOOTH (SEMM-TYPE), DBL-ACTION	33 CM	52255-68A	52255-68B	 <i>Type 17: Lightweight Carbon -Fiber w/ RF Post</i>	 <i>Type 18: Carbon-Fiber w/ RF Post, Ratchet / Ratchet Defeating</i>
	36 CM	52236-68A	52236-68B		
	45 CM	52155-68A	52155-68B		
	24 CM	52224-68A	52224-68B		
 5MM Ø, BIOPSY HOOK PUNCH, SINGLE-ACTION	33 CM	52255-71A	52255-71B	 <i>Type 17: Lightweight Carbon -Fiber w/ RF Post</i>	 <i>Type 18: Carbon-Fiber w/ RF Post, Ratchet / Ratchet Defeating</i>
	36 CM	52236-71A	52236-71B		
	45 CM	52155-71A	52155-71B		
	24 CM	52224-71A	52224-71B		
 5MM Ø, BIOPSY PUNCH WITH TOOTH, SINGLE-ACTION	33 CM	52255-72A	52255-72B	 <i>Type 17: Lightweight Carbon -Fiber w/ RF Post</i>	 <i>Type 18: Carbon-Fiber w/ RF Post, Ratchet / Ratchet Defeating</i>
	36 CM	52236-72A	52236-72B		
	45 CM	52155-72A	52155-72B		
	24 CM	52224-72A	52224-72B		
 5MM Ø, BIOPSY PUNCH, SINGLE-ACTION	33 CM	52255-73A	52255-73B	 <i>Type 17: Lightweight Carbon -Fiber w/ RF Post</i>	 <i>Type 18: Carbon-Fiber w/ RF Post, Ratchet / Ratchet Defeating</i>
	36 CM	52236-73A	52236-73B		
	45 CM	52155-73A	52155-73B		
	24 CM	52224-73A	52224-73B		

TIP & STYLE + HANDLE TYPE = COMPLETE INSTRUMENT
 52255-01B + TYPE 1 = 52255-01B1

This section features our 5mm Modular Three-Piece Take Apart instruments, as well as the replacement inserts. Our Three-Piece Modular Instruments are designed to come apart for superior cleaning. They are also completely interchangeable with any of our Laparoscopic Handles found on Page 28, giving Hospitals & Surgery Centers the flexibility to quickly assemble instruments without having to match up every insert, shaft, & handle.

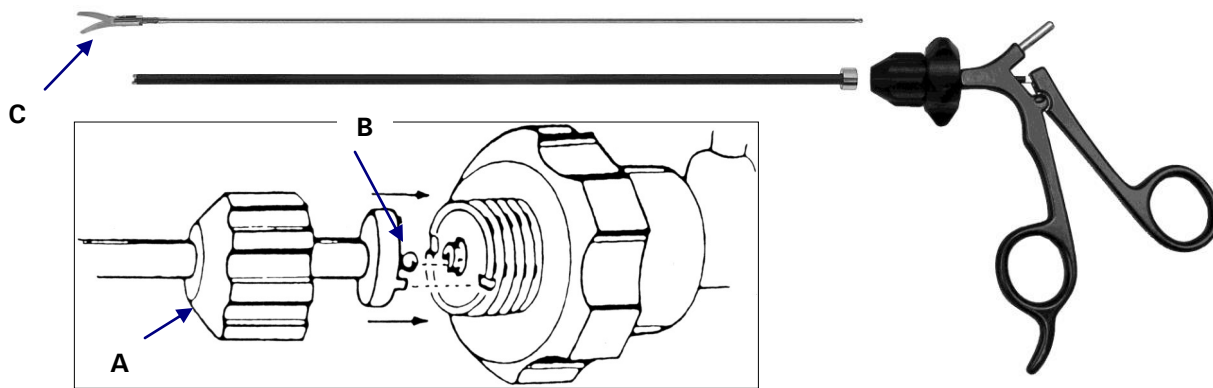

















ASSEMBLY:

1. Turn the **Tip (C)** clockwise into the shaft
2. Set the handle in the open position & engage the **Ball (B)** of **Inner Rod** into its fixation in the handle port.
3. Turn main **Screw Cap (A)** clockwise until it engages the handle.

TIP & STYLE + HANDLE TYPE = COMPLETE INSTRUMENT
 52255-01C + TYPE 1 = 52255-01C1

GRASPERS & DISSECTORS



	<u>Length</u>	<u>Style C:</u>	<u>Insert Only:</u>	<u>Recommended</u>	<u>Optional</u>
 5MM Ø, MICRO REDDICK-OLSEN GRASPER/DISSECTOR	33 CM	52255-01C	52255-01I	 Type 1: <u>Insulated Stainless Steel w/ RF Post</u>	 Type 3: <u>Non-Insulated Stainless Steel</u>
	36 CM	52236-01C	52236-01I		
	45 CM	52155-01C	52155-01I		
	24 CM	52224-01C	52224-01I		
 5MM Ø, STANDARD GRASPER/DISSECTOR WITH SPOON	33 CM	52255-02C	52255-02I	 Type 5: <u>Lightweight Carbon-Fiber w/ RF Post</u>	 Type 7: <u>Lightweight Carbon-Fiber w/ RF Post, Ratchet / Ratchet Defeating</u>
	36 CM	52236-02C	52236-02I		
	45 CM	52155-02C	52155-02I		
	24 CM	52224-02C	52224-02I		
 5MM Ø, STANDARD GRASPER/DISSECTOR W/ SPOON, LONG 20 MM JAW	52255-01A	52255-52C	52255-52I	OR	 Type 9: <u>Lightweight Carbon-Fiber w/ RF Post, w/ Large Finger Loops</u>
	52236-01A	52236-52C	52236-52I		
	52155-01A	52155-52C	52155-52I		
	52224-01A	52224-52C	52224-52I		
 5MM Ø, STANDARD GRASPER/DISSECTOR	33 CM	52255-03C	52255-03I	 Type 17: <u>Lightweight Carbon-Fiber w/ RF Post</u>	 Type 18: <u>Carbon-Fiber w/ RF Post, Ratchet / Ratchet Defeating</u>
	36 CM	52236-03C	52236-03I		
	45 CM	52155-03C	52155-03I		
	24 CM	52224-03C	52224-03I		
 5MM Ø, BULLET-NOSE GRASPER/DISSECTOR WITH SPOON	33 CM	52255-04C	52255-04I	OR	
	36 CM	52236-04C	52236-04I		
	45 CM	52155-04C	52155-04I		
	24 CM	52224-04C	52224-04I		
 5MM Ø, TAPERED DOLPHIN-NOSE GRASPER/DISSECTOR	33 CM	52255-05C	52255-05I		
	36 CM	52236-05C	52236-05I		
	45 CM	52155-05C	52155-05I		
	24 CM	52224-05C	52224-05I		
 5MM Ø, TAPERED DOLPHIN-NOSE GRASPER/DISSECTOR W/ SPOON	33 CM	52255-105C	52255-105I		
	36 CM	52236-105C	52236-105I		
	45 CM	52155-105C	52155-105I		
	24 CM	52224-105C	52224-105I		
 5MM Ø, MARYLAND GRASPER/DISSECTOR, 18MM LENGTH TIP	33 CM	52255-06A	52255-06B		
	36 CM	52236-06A	52236-06B		
	45 CM	52155-06A	52155-06B		
	24 CM	52224-06A	52224-06B		
 5MM Ø, TAPERED MARYLAND GRASPER/DISSECTOR, 18MM LENGTH TIP	33 CM	52255-99C	52255-99I		
	36 CM	52236-99C	52236-99I		
	45 CM	52155-99C	52155-99I		
	24 CM	52224-99C	52224-99I		
 5MM Ø, SHORT MARYLAND GRASPER/DISSECTOR, 15MM LENGTH TIP	33 CM	52255-91C	52255-91I		
	36 CM	52236-91C	52236-91I		
	45 CM	52155-91C	52155-91I		
	24 CM	52224-91C	52224-91I		

TIP & STYLE + HANDLE TYPE = COMPLETE INSTRUMENT
 52255-01B + TYPE 1 = 52255-01B1

GRASPERS & DISSECTORS



	<u>Length</u>	<u>Style C:</u>	<u>Insert Only:</u>
5MM Ø, MIXTER GRASPER/ DISSECTOR RIGHT ANGLE (LONG)	33 CM	52255-07C	52255-07I
	36 CM	52236-07C	52236-07I
	45 CM	52155-07C	52155-07I
	24 CM	52224-07C	52224-07I
5MM Ø, MIXTER GRASPER/ DISSECTOR, SHORT RIGHT ANGLE	33 CM	52255-59C	52255-59I
	36 CM	52236-59C	52236-59I
	45 CM	52155-59C	52155-59I
	24 CM	52224-59C	52224-59I
5MM Ø, MIXTER GRASPER/ DISSECTOR 45 DEGREE ANGLE	33 CM	52255-08C	52255-08I
	36 CM	52236-08C	52236-08I
	45 CM	52155-08C	52155-08I
	24 CM	52224-08C	52224-08I
5MM Ø, DUCKBILL GRASPER/ DISSECTOR	33 CM	52255-09C	52255-09I
	36 CM	52236-09C	52236-09I
	45 CM	52155-09C	52155-09I
	24 CM	52224-09C	52224-09I
5MM Ø, NEEDLE-NOSE GRASPER/DISSECTOR	33 CM	52255-10C	52255-10I
	36 CM	52236-10C	52236-10I
	45 CM	52155-10C	52155-10I
	24 CM	52224-10C	52224-10I
5MM Ø, KELLY GRASPER/ DISSECTOR	33 CM	52255-11C	52255-11I
	36 CM	52236-11C	52236-11I
	45 CM	52155-11C	52155-11I
	24 CM	52224-11C	52224-11I
5MM Ø, LONG REACH, RIGHT ANGLE DISSECTOR, DBL- ACTION (REQUIRES LARGER CANNULA)	33 CM	52255-53C	52255-53I
	36 CM	52236-53C	52236-53I
	45 CM	52155-53C	52155-53I
	24 CM	52224-53C	52224-53I
5MM Ø, PETELIN DISSECTOR, 60 DEG. ANGLE LEFT, SINGLE-ACTION	33 CM	52255-12C	52255-12I
	36 CM	52236-12C	52236-12I
	45 CM	52155-12C	52155-12I
	24 CM	52224-12C	52224-12I
5MM Ø, PETELIN DISSECTOR, 30 DEG. ANGLE LEFT, SINGLE- ACTION	33 CM	52255-13C	52255-13I
	36 CM	52236-13C	52236-13I
	45 CM	52155-13C	52155-13I
	24 CM	52224-13C	52224-13I
5MM Ø, MICRO GRASPER/ DISSECTOR, FENESTRATED	33 CM	52255-14C	52255-14I
	36 CM	52236-14C	52236-14I
	45 CM	52155-14C	52155-14I
	24 CM	52224-14C	52224-14I

<u>Recommended</u>	<u>Optional</u>
	
Type 1: <i>Insulated Stainless Steel w/ RF Post</i>	Type 3: <i>Non-Insulated Stainless Steel</i>
OR	
	Type 7: <i>Lightweight Carbon-Fiber w/ RF Post, Ratchet / Ratchet Defeating</i>
Type 5: <i>Lightweight Carbon-Fiber w/ RF Post</i>	
OR	Type 9: <i>Lightweight Carbon-Fiber w/ RF Post, w/ Large Finger Loops</i>
	
Type 17: <i>Lightweight Carbon-Fiber w/ RF Post</i>	Type 18: <i>Carbon-Fiber w/ RF Post, Ratchet / Ratchet Defeating</i>

TIP & STYLE + HANDLE TYPE = COMPLETE INSTRUMENT
 52255-01B + TYPE 1 = 52255-01B1























GRASPERS & DISSECTORS

STYLE C:
MODULAR 3-PIECE TAKE APART



INSERT ONLY:



















	<u>Length</u>	<u>Style C:</u>	<u>Insert Only:</u>	<u>Recommended</u>	<u>Optional</u>
 5MM Ø, COBRA GRASPER, DOUBLE-ACTION	33 CM	52255-15C	52255-15I	 Type 2: <u>Insulated Stainless Steel w/ RF Post & Ratchet</u>	 Type 4: <u>Non-Insulated Stainless Steel w/ Ratchet</u>
	36 CM	52236-15C	52236-15I		
	45 CM	52155-15C	52155-15I		
	24 CM	52224-15C	52224-15I		
 5MM Ø, BABCOCK GRASPER, FENESTRATED TIP	33 CM	52255-16C	52255-16I	 Type 7: <u>Lightweight Carbon-Fiber w/ RF Post, Ratchet / Ratchet Defeating</u>	 Type 9: <u>Lightweight Carbon-Fiber w/ RF Post, Ratchet / Ratchet Defeating w/ Large Finger Loops</u>
	36 CM	52236-16C	52236-16I		
	45 CM	52155-16C	52155-16I		
	24 CM	52224-16C	52224-16I		
 5MM Ø, BABCOCK GRASPER, AXIS STYLE, FENESTRATED TIP	33 CM	52255-116C	52255-116I	 Type 6: <u>Lightweight Carbon-Fiber w/ RF Post & Ratchet</u>	 Type 8: <u>Lightweight Carbon-Fiber w/ RF Post, French On/Off Ratchet</u>
	36 CM	52236-116C	52236-116I		
	45 CM	52155-116C	52155-116I		
	24 CM	52224-116C	52224-116I		
 5MM Ø, BABCOCK GRASPER- SHORT: DELICATE APPLICATION	33 CM	52255-17C	52255-17I	<p style="text-align: center;">OR</p>  Type 18: <u>Carbon-Fiber w/ RF Post, Ratchet / Ratchet Defeating</u>	
	36 CM	52236-17C	52236-17I		
	45 CM	52155-17C	52155-17I		
	24 CM	52224-17C	52224-17I		
 5MM Ø, ALLIS GRASPER, SHORT VERSION, SINGLE ACTION	33 CM	52255-18C	52255-18I	<p style="text-align: center;">OR</p>  Type 18: <u>Carbon-Fiber w/ RF Post, Ratchet / Ratchet Defeating</u>	
	36 CM	52236-18C	52236-18I		
	45 CM	52155-18C	52155-18I		
	24 CM	52224-18C	52224-18I		
 5MM Ø, ALLIS GRASPER, SHORT VERSION, 3 X 4 TEETH, SERRATED, DOUBLE- ACTION	33 CM	52255-19C	52255-19I	 Type 18: <u>Carbon-Fiber w/ RF Post, Ratchet / Ratchet Defeating</u>	
	36 CM	52236-19C	52236-19I		
	45 CM	52155-19C	52155-19I		
	24 CM	52224-19C	52224-19I		
 5MM Ø, ATRAUMATIC ALLIS GRASPER, SHORT VERSION, SERRATED W/ DOUBLE ROW OF TEETH, DOUBLE-ACTION	33 CM	52255-119C	52255-119I	 Type 18: <u>Carbon-Fiber w/ RF Post, Ratchet / Ratchet Defeating</u>	
	36 CM	52236-119C	52236-119I		
	45 CM	52155-119C	52155-119I		
	24 CM	52224-119C	52224-119I		
 5MM Ø, ATRAUMATIC ALLIS GRASPER, LONG VERSION, SERRATED W/ DOUBLE ROW OF TEETH, DOUBLE-ACTION	33 CM	52255-219A	52255-219B	 Type 18: <u>Carbon-Fiber w/ RF Post, Ratchet / Ratchet Defeating</u>	
	36 CM	52236-219A	52236-219B		
	45 CM	52155-219A	52155-219B		
	24 CM	52224-219A	52224-219B		
 5MM Ø, ALLIS GRASPER, MEDIUM VERSION, (WECK STYLE)	33 CM	52255-20C	52255-20I	 Type 18: <u>Carbon-Fiber w/ RF Post, Ratchet / Ratchet Defeating</u>	
	36 CM	52236-20C	52236-20I		
	45 CM	52155-20C	52155-20I		
	24 CM	52224-20C	52224-20I		
 5MM Ø, ALLIS GRASPER, STANDARD VERSION	33 CM	52255-21C	52255-21I	 Type 18: <u>Carbon-Fiber w/ RF Post, Ratchet / Ratchet Defeating</u>	
	36 CM	52236-21C	52236-21I		
	45 CM	52155-21C	52155-21I		
	24 CM	52224-21C	52224-21I		

TIP & STYLE + HANDLE TYPE = COMPLETE INSTRUMENT
 52255-01B + TYPE 1 = 52255-01B1

GRASPERS & DISSECTORS



	<u>Length</u>	<u>Style C:</u>	<u>Insert Only:</u>
	33 CM	52255-57C	52255-57I
	36 CM	52236-57C	52236-57I
	45 CM	52155-57C	52155-57I
	24 CM	52224-57C	52224-57I
	33 CM	52255-22cC	52255-22I
	36 CM	52236-22C	52236-22I
	45 CM	52155-22C	52155-22I
	24 CM	52224-22C	52224-22I
	33 CM	52255-23C	52255-23I
	36 CM	52236-23C	52236-23I
	45 CM	52155-23C	52155-23I
	24 CM	52224-23C	52224-23I
	33 CM	52255-58C	52255-58I
	36 CM	52236-58C	52236-58I
	45 CM	52155-58C	52155-58I
	24 CM	52224-58C	52224-58I
	33 CM	52255-159C	52255-159I
	36 CM	52236-159C	52236-159I
	45 CM	52155-159C	52155-159I
	24 CM	52224-159C	52224-159I
	33 CM	52255-160C	52255-160I
	36 CM	52236-160C	52236-160I
	45 CM	52155-160C	52155-160I
	24 CM	52224-160C	52224-160I
	33 CM	52255-46C	52255-46I
	36 CM	52236-46C	52236-46I
	45 CM	52155-46C	52155-46I
	24 CM	52224-46C	52224-46I
	33 CM	52255-24C	52255-24I
	36 CM	52236-24C	52236-24I
	45 CM	52155-24C	52155-24I
	24 CM	52224-24C	52224-24I
	33 CM	52255-25C	52255-25I
	36 CM	52236-25C	52236-25I
	45 CM	52155-25C	52155-25I
	24 CM	52224-25C	52224-25I
	33 CM	52255-26C	52255-26I
	36 CM	52236-26C	52236-26I
	45 CM	52155-26C	52155-26I
	24 CM	52224-26C	52224-26I





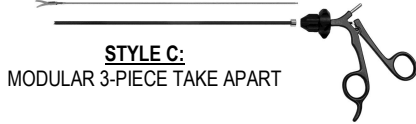

<u>Recommended</u>	<u>Optional</u>
	
Type 2: <i>Insulated Stainless Steel w/ RF Post & Ratchet</i>	Type 4: <i>Non-Insulated Stainless Steel w/ Ratchet</i>
OR	
	Type 7: <i>Lightweight Carbon-Fiber w/ RF Post, Ratchet / Ratchet Defeating</i>
Type 6: <i>Lightweight Carbon-Fiber w/ RF Post & Ratchet</i>	OR
	
Type 9: <i>Lightweight Carbon-Fiber w/ RF Post, Ratchet / Ratchet Defeating w/ Large Finger Loops</i>	Type 8: <i>Lightweight Carbon-Fiber w/ RF Post, French On/Off Ratchet</i>
	
	Type 18: <i>Carbon-Fiber w/ RF Post, Ratchet / Ratchet Defeating</i>

TIP & STYLE + **HANDLE TYPE** = **COMPLETE INSTRUMENT**
 52255-01B + TYPE 1 = 52255-01B1

GRASPERS & DISSECTORS











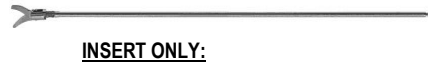
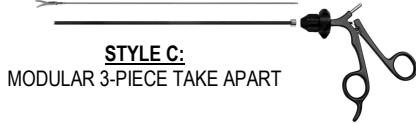





















	<u>Length</u>	<u>Style C:</u>	<u>Insert Only:</u>
5MM Ø, "WINER" STYLE FUNDUS MAXI GRASPER	33 CM	52255-326C	52255-326I
	36 CM	52236-326C	52236-326I
	45 CM	52155-326C	52155-326I
	24 CM	52224-326C	52224-326I
5MM Ø, "MCKERNAN" STYLE FUNDUS MAXI GRASPER	33 CM	52255-126C	52255-126I
	36 CM	52236-126C	52236-126I
	45 CM	52155-126C	52155-126I
	24 CM	52224-126C	52224-126I
5MM Ø, DOUBLE CUP FENESTRATED FUNDUS MAXI GRASPER	33 CM	52255-226C	52255-226I
	36 CM	52236-226C	52236-226I
	45 CM	52155-226C	52155-226I
	24 CM	52224-226C	52224-226I
5MM Ø, ENDO CLINCH FENESTRATED GRASPER	33 CM	52255-27C	52255-27I
	36 CM	52236-27C	52236-27I
	45 CM	52155-27C	52155-27I
	24 CM	52224-27C	52224-27I
5MM Ø, RETRO FACING RAT-TOOTH GRASPER w/ ATRAUMATIC CUP	33 CM	52255-28C	52255-28I
	36 CM	52236-28C	52236-28I
	45 CM	52155-28C	52155-28I
	24 CM	52224-28C	52224-28I
5MM Ø, ALLIGATOR GRASPER, 10MM JAW, RETRO FACING TEETH, DBL-ACTION	33 CM	52255-29C	52255-29I
	36 CM	52236-29C	52236-29I
	45 CM	52155-29C	52155-29I
	24 CM	52224-29C	52224-29I
5MM Ø, ALLIGATOR GRASPER, 20MM JAW, RETRO FACING TEETH, DBL-ACTION	33 CM	52255-129C	52255-129I
	36 CM	52236-129C	52236-129I
	45 CM	52155-129C	52155-129I
	24 CM	52224-129C	52224-129I
5MM Ø, ALLIGATOR GRASPER, RETRO FACING TEETH, SINGLE-ACTION	33 CM	52255-30C	52255-30I
	36 CM	52236-30C	52236-30I
	45 CM	52155-30C	52155-30I
	24 CM	52224-30C	52224-30I
5MM Ø, CUP SHAPED GRASPER WITH RETRO FACING TEETH, DBL-ACTION	33 CM	52255-58C	52255-58I
	36 CM	52236-58C	52236-58I
	45 CM	52155-58C	52155-58I
	24 CM	52224-58C	52224-58I
5MM Ø, WAVE GRASPER, LONG BEVELED EDGE JAW, DBL-ACTION	33 CM	52255-32C	52255-32I
	36 CM	52236-32C	52236-32I
	45 CM	52155-32C	52155-32I
	24 CM	52224-32C	52224-32I

<u>Recommended</u>	<u>Optional</u>
 Type 2: <i>Insulated Stainless Steel w/ RF Post & Ratchet</i>	 Type 4: <i>Non-Insulated Stainless Steel w/ Ratchet</i>
OR	 Type 7: <i>Lightweight Carbon-Fiber w/ RF Post, Ratchet / Ratchet Defeating</i>
 Type 6: <i>Lightweight Carbon-Fiber w/ RF Post & Ratchet</i>	 Type 8: <i>Lightweight Carbon-Fiber w/ RF Post, French On/Off Ratchet</i>
OR	 Type 9: <i>Lightweight Carbon-Fiber w/ RF Post, Ratchet / Ratchet Defeating w/ Large Finger Loops</i>
	 Type 18: <i>Carbon-Fiber w/ RF Post, Ratchet / Ratchet Defeating</i>

TIP & STYLE + HANDLE TYPE = COMPLETE INSTRUMENT
 52255-01B + TYPE 1 = 52255-01B1

GRASPERS & DISSECTORS



	<u>Length</u>	<u>Style C:</u>	<u>Insert Only:</u>	<u>Recommended</u>	<u>Optional</u>
	33 CM	52255-33C	52255-33I		
	36 CM	52236-33C	52236-33I		
	45 CM	52155-33C	52155-33I		
	24 CM	52224-33C	52224-33I		
	33 CM	52255-36C	52255-36I		
	36 CM	52236-36C	52236-36I		
	45 CM	52155-36C	52155-36I		
	24 CM	52224-36C	52224-36I		
	33 CM	52255-136C	52255-136I		
	36 CM	52236-136C	52236-136I		
	45 CM	52155-136C	52155-136I		
	24 CM	52224-136C	52224-136I		
	33 CM	52255-34C	52255-34I		
	36 CM	52236-34C	52236-34I		
	45 CM	52155-34C	52155-34I		
	24 CM	52224-34C	52224-34I		
	33 CM	52255-35C	52255-35I		
	36 CM	52236-35C	52236-35I		
	45 CM	52155-35C	52155-35I		
	24 CM	52224-35C	52224-35I		
	33 CM	52255-134C	52255-134I		
	36 CM	52236-134C	52236-134I		
	45 CM	52155-134C	52155-134I		
	24 CM	52224-134C	52224-134I		
	33 CM	52255-135C	52255-135I		
	36 CM	52236-135C	52236-135I		
	45 CM	52155-135C	52155-135I		
	24 CM	52224-135C	52224-135I		
	33 CM	52255-37C	52255-37I		
	36 CM	52236-37C	52236-37I		
	45 CM	52155-37C	52155-37I		
	24 CM	52224-37C	52224-37I		
	33 CM	52255-38C	52255-38I		
	36 CM	52236-38C	52236-38I		
	45 CM	52155-38C	52155-38I		
	24 CM	52224-38C	52224-38I		
	33 CM	52255-39C	52255-39I		
	36 CM	52236-39C	52236-39I		
	45 CM	52155-39C	52155-39I		
	24 CM	52224-39C	52224-39I		

OR

OR

TIP & STYLE + **HANDLE TYPE** = **COMPLETE INSTRUMENT**
 52255-01B + TYPE 1 = 52255-01B1

GRASPERS & DISSECTORS

STYLE C:
MODULAR 3-PIECE TAKE APART

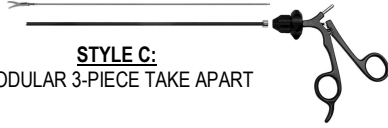

INSERT ONLY:



	<u>Length</u>	<u>Style C:</u>	<u>Insert Only:</u>
5MM Ø, FENESTRATED GRASPER, 40 MM DBL-ACTION JAW	33 CM	52255-40C	52255-40I
	36 CM	52236-40C	52236-40I
	45 CM	52155-40C	52155-40I
	24 CM	52224-40C	52224-40I
5MM Ø, JOHAN FENESTRATED GRASPER, 22 MM SINGLE-ACTION FLAT JAWS	33 CM	52255-41C	52255-41I
	36 CM	52236-41C	52236-41I
	45 CM	52155-41C	52155-41I
	24 CM	52224-41C	52224-41I
5MM Ø, JOHAN FENESTRATED GRASPER, 45 MM SGL-ACTION FLAT JAWS	33 CM	52255-42C	52255-42I
	36 CM	52236-42C	52236-42I
	45 CM	52155-42C	52155-42I
	24 CM	52224-42C	52224-42I
5MM Ø, KOCHER GRASPER, 1 X 2 TEETH, SINGLE-ACTION FLAT JAWS	33 CM	52255-43C	52255-43I
	36 CM	52236-43C	52236-43I
	45 CM	52155-43C	52155-43I
	24 CM	52224-43C	52224-43I
5MM Ø, KOCHER GRASPER, 1 X 2 TEETH, DOUBLE-ACTION (WECK TYPE)	33 CM	52255-44C	52255-44I
	36 CM	52236-44C	52236-44I
	45 CM	52155-44C	52155-44I
	24 CM	52224-44C	52224-44I
5MM Ø, SCHROEDER TENACULUM GRASPER, SINGLE TEETH	33 CM	52255-45C	52255-45I
	36 CM	52236-45C	52236-45I
	45 CM	52155-45C	52155-45I
	24 CM	52224-45C	52224-45I
5MM Ø, SCHROEDER TENACULUM GRASPER, SINGLE TEETH w/ EXTRA GUIDE TOOTH	33 CM	52255-94C	52255-94I
	36 CM	52236-94C	52236-94I
	45 CM	52155-94C	52155-94I
	24 CM	52224-94C	52224-94I
5MM Ø, BLUNT ATRAUMATIC GRASPING FORCEPS, DOUBLE-ACTION	33 CM	52255-47C	52255-47I
	36 CM	52236-47C	52236-47I
	45 CM	52155-47C	52155-47I
	24 CM	52224-47C	52224-47I
5MM Ø, BLUNT ATRAUMATIC GRASPER W/ CROSS-SERRATED TIPS, DBL-ACTION	33 CM	52255-56C	52255-56I
	36 CM	52236-56C	52236-56I
	45 CM	52155-56C	52155-56I
	24 CM	52224-56C	52224-56I
5MM Ø, BULLET NOSE GRASPER/DISSECTOR, TC, MICRO DIAMOND JAW PATTERN DOUBLE-ACTION	33 CM	52255-48C	52255-48I
	36 CM	52236-48C	52236-48I
	45 CM	52155-48C	52155-48I
	24 CM	52224-48C	52224-48I

Recommended



Type 2:
Insulated Stainless Steel w/ RF Post & Ratchet

Optional



Type 4:
Non-Insulated Stainless Steel w/ Ratchet

OR



Type 6:
Lightweight Carbon-Fiber w/ RF Post & Ratchet



Type 7:
Lightweight Carbon-Fiber w/ RF Post, Ratchet / Ratchet Defeating

OR



Type 9:
Lightweight Carbon-Fiber w/ RF Post, Ratchet / Ratchet Defeating w/ Large Finger Loops

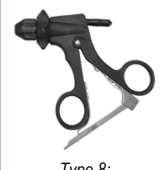

Type 8:
Lightweight Carbon-Fiber w/ RF Post, French On/Off Ratchet



Type 18:
Carbon-Fiber w/ RF Post, Ratchet / Ratchet Defeating

TIP & STYLE + HANDLE TYPE = COMPLETE INSTRUMENT
52255-01B + TYPE 1 = 52255-01B1









GRASPERS & DISSECTORS

STYLE C:
MODULAR 3-PIECE TAKE APART



INSERT ONLY:



	<u>Length</u>	<u>Style C:</u>	<u>Insert Only:</u>	
	5MM Ø, BULLET NOSE GRASPER/DISSECTOR, TC, CROSS DIAMOND JAW PATTERN DOUBLE-ACTION	33 CM	52255-49C	52255-49I
		36 CM	52236-49C	52236-49I
		45 CM	52155-49C	52155-49I
		24 CM	52224-49C	52224-49I
	5MM Ø, LONG TAPERED GRASPER W/ ATRAUMATIC TEETH, DBL-ACTION	33 CM	52255-51C	52255-51I
		36 CM	52236-51C	52236-51I
		45 CM	52155-51C	52155-51I
		24 CM	52224-51C	52224-51I
	5MM Ø, WAVE GRASPER, POINTED, SINGLE-ACTION	33 CM	52255-54C	52255-54I
		36 CM	52236-54C	52236-54I
		45 CM	52155-54C	52155-54I
		24 CM	52224-54C	52224-54I
	5MM Ø, WAVE GRASPER, BLUNT, SINGLE-ACTION	33 CM	52255-55C	52255-55I
		36 CM	52236-55C	52236-55I
		45 CM	52155-55C	52155-55I
		24 CM	52224-55C	52224-55I
	5MM Ø, "DAVOL" TYPE, ATRAUMATIC GRASPER, SCOOPED-OUT JAW & GENTLY MASHING TEETH	33 CM	52255-90C	52255-90I
		36 CM	52236-90C	52236-90I
		45 CM	52155-90C	52155-90I
		24 CM	52224-90C	52224-90I
	5MM Ø, "ACCESS" TYPE, FENESTRATED GRASPER, 20MM JAW W/ AGGRESSIVE TEETH FOR POSITIVE EXTRA STRONG TISSUE HOLDING	33 CM	52255-91C	52255-91I
		36 CM	52236-91C	52236-91I
		45 CM	52155-91C	52155-91I
		24 CM	52224-91C	52224-91I
	5MM Ø, "SOFT TOUCH" GRASPER, 22 MM JAW, ATRAUMATIC TEFLON INSERTS FOR THE LIGHT MINIMUM TISSUE TRAUMA TOUCH YET POSITIVE HOLDING	33 CM	52255-144C	52255-144I
		36 CM	52236-144C	52236-144I
		45 CM	52155-144C	52155-144I
		24 CM	52224-144C	52224-144I
	5MM Ø, "SOFT TOUCH" GRASPER, 40 MM JAW, ATRAUMATIC TEFLON INSERTS FOR THE LIGHT MINIMUM TISSUE TRAUMA TOUCH YET POSITIVE HOLDING	33 CM	52255-145C	52255-145I
		36 CM	52236-145C	52236-145I
		45 CM	52155-145C	52155-145I
		24 CM	52224-145C	52224-145I

Recommended

Optional

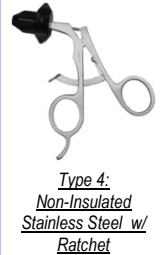

OR



OR

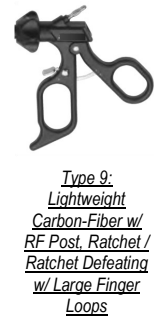

TIP & STYLE + HANDLE TYPE = COMPLETE INSTRUMENT
52255-01B + TYPE 1 = 52255-01B1





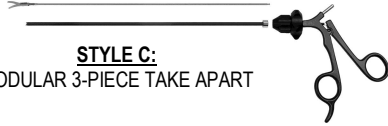

























FORCEPS & SCISSORS

STYLE C:
MODULAR 3-PIECE TAKE APART



INSERT ONLY:























	<u>Length</u>	<u>Style C:</u>	<u>Insert Only:</u>	<u>Recommended</u>	<u>Optional</u>
 5MM Ø, HOOK SCISSORS, SINGLE-ACTION	33 CM	52255-60C	52255-60I	 Type 1: <u>Insulated Stainless Steel w/ RF Post</u>	 Type 3: <u>Non-Insulated Stainless Steel</u>
	36 CM	52236-60C	52236-60I		
	45 CM	52155-60C	52155-60I		
	24 CM	52224-60C	52224-60I		
 5MM Ø, MICRO TIP SCISSORS, STRAIGHT, SINGLE-ACTION	33 CM	52255-61C	52255-61I	 Type 1: <u>Insulated Stainless Steel w/ RF Post</u>	 Type 7: <u>Lightweight Carbon-Fiber w/ RF Post, Ratchet / Ratchet Defeating</u>
	36 CM	52236-61C	52236-61I		
	45 CM	52155-61C	52155-61I		
	24 CM	52224-61C	52224-61I		
 5MM Ø, MICRO TIP SCISSORS, CURVED, SINGLE-ACTION	33 CM	52255-62C	52255-62I	 Type 1: <u>Insulated Stainless Steel w/ RF Post</u>	 Type 7: <u>Lightweight Carbon-Fiber w/ RF Post, Ratchet / Ratchet Defeating</u>
	36 CM	52236-62C	52236-62I		
	45 CM	52155-62C	52155-62I		
	24 CM	52224-62C	52224-62I		
 5MM Ø, METZENBAUM SCISSORS, STRAIGHT, LONG BLADE (20MM TIP)	33 CM	52255-63C	52255-63I	<p style="text-align: center;">OR</p>  Type 5: <u>Lightweight Carbon-Fiber w/ RF Post</u>	 Type 9: <u>Lightweight Carbon-Fiber w/ RF Post, w/ Large Finger Loops</u>
	36 CM	52236-63C	52236-63I		
	45 CM	52155-63C	52155-63I		
	24 CM	52224-63C	52224-62I		
 5MM Ø, METZENBAUM SCISSORS, STRAIGHT, SHORT BLADE (12MM TIP)	33 CM	52255-64C	52255-64I	<p style="text-align: center;">OR</p>  Type 5: <u>Lightweight Carbon-Fiber w/ RF Post</u>	 Type 9: <u>Lightweight Carbon-Fiber w/ RF Post, w/ Large Finger Loops</u>
	36 CM	52236-64C	52236-64I		
	45 CM	52155-64C	52155-64I		
	24 CM	52224-64C	52224-64I		
 5MM Ø, METZENBAUM SCISSORS, CURVED, LONG BLADE (18MM TIP)	33 CM	52255-65C	52255-65I	 Type 5: <u>Lightweight Carbon-Fiber w/ RF Post</u>	 Type 9: <u>Lightweight Carbon-Fiber w/ RF Post, w/ Large Finger Loops</u>
	36 CM	52236-65C	52236-65I		
	45 CM	52155-65C	52155-65I		
	24 CM	52224-65C	52224-65I		
 5MM Ø, METZENBAUM SCISSORS, HARDENED STEEL, CURVED BLADE (16MM TIP)	33 CM	52255-66C	52255-66I	<p style="text-align: center;">OR</p>  Type 5: <u>Lightweight Carbon-Fiber w/ RF Post</u>	 Type 9: <u>Lightweight Carbon-Fiber w/ RF Post, w/ Large Finger Loops</u>
	36 CM	52236-66C	52236-66I		
	45 CM	52155-66C	52155-66I		
	24 CM	52224-66C	52224-66I		
 5MM Ø, METZENBAUM SCISSORS, CURVED, SHORT BLADE (11MM TIP)	33 CM	52255-166C	52255-166I	 Type 5: <u>Lightweight Carbon-Fiber w/ RF Post</u>	 Type 9: <u>Lightweight Carbon-Fiber w/ RF Post, w/ Large Finger Loops</u>
	36 CM	52236-166C	52236-166I		
	45 CM	52155-166C	52155-166I		
	24 CM	52224-166C	52224-166I		
 5MM Ø, PERITONEAL SCISSORS, SINGLE-ACTION	33 CM	52255-67C	52255-67I	 Type 17: <u>Lightweight Carbon-Fiber w/ RF Post</u>	 Type 18: <u>Carbon-Fiber w/ RF Post, Ratchet / Ratchet Defeating</u>
	36 CM	52236-67C	52236-67I		
	45 CM	52155-67C	52155-67I		
	24 CM	52224-67C	52224-67I		
 5MM Ø, HOOK SCISSORS, TS, EXTRA HARD STEEL	33 CM	52255-76C	52255-76I	 Type 17: <u>Lightweight Carbon-Fiber w/ RF Post</u>	 Type 18: <u>Carbon-Fiber w/ RF Post, Ratchet / Ratchet Defeating</u>
	36 CM	52236-76C	52236-76I		
	45 CM	52155-76C	52155-76I		
	24 CM	52224-76C	52224-76I		

TIP & STYLE + HANDLE TYPE = COMPLETE INSTRUMENT
 52255-01B + TYPE 1 = 52255-01B1

FORCEPS & SCISSORS



	<u>Length</u>	<u>Style C:</u>	<u>Insert Only:</u>	<u>Recommended</u>	<u>Optional</u>
 5MM Ø, PERITONEAL SCISSORS, TS, EXTRA HARD STEEL, SINGLE-ACTION	33 CM	52255-77C	52255-77I	 <u>Type 1:</u> <u>Insulated Stainless</u> <u>Steel w/ RF Post</u>	 <u>Type 3:</u> <u>Non-Insulated</u> <u>Stainless Steel</u>
	36 CM	52236-77C	52236-77I		
	45 CM	52155-77C	52155-77I		
	24 CM	52224-77C	52224-77I		
 5MM Ø, PERITONEAL SCISSORS, TS, EXTRA HARD STEEL, DOUBLE-ACTION	33 CM	52255-78C	52255-78I	 <u>Type 5:</u> <u>Lightweight Carbon</u> <u>-Fiber w/ RF Post</u>	 <u>Type 7:</u> <u>Lightweight</u> <u>Carbon-Fiber w/</u> <u>RF Post, Ratchet /</u> <u>Ratchet Defeating</u>
	36 CM	52236-78C	52236-78I		
	45 CM	52155-78C	52155-78I		
	24 CM	52224-78C	52224-78I		
 5MM Ø, BIOPSY SPOON FORCEPS W/ TOOTH, (SEMM-TYPE) SINGLE-ACTION	33 CM	52255-79C	52255-79I	<p style="text-align: center;">OR</p>  <u>Type 9:</u> <u>Lightweight</u> <u>Carbon-Fiber w/</u> <u>RF Post, w/ Large</u> <u>Finger Loops</u>	
	36 CM	52236-79C	52236-79I		
	45 CM	52155-79C	52155-79I		
	24 CM	52224-79C	52224-79I		
 5MM Ø, BIOPSY SPOON FORCEPS, SINGLE-ACTION	33 CM	52255-69C	52255-69I	 <u>Type 17:</u> <u>Lightweight Carbon</u> <u>-Fiber w/ RF Post</u>	 <u>Type 18:</u> <u>Carbon-Fiber w/</u> <u>RF Post, Ratchet /</u> <u>Ratchet Defeating</u>
	36 CM	52236-69C	52236-69I		
	45 CM	52155-69C	52155-69I		
	24 CM	52224-69C	52224-69I		
 5MM Ø, BIOPSY SPOON FORCEPS, DOUBLE-ACTION	33 CM	52255-70C	52255-70I	<p style="text-align: center;">OR</p>  <u>Type 17:</u> <u>Lightweight Carbon</u> <u>-Fiber w/ RF Post</u>	
	36 CM	52236-70C	52236-70I		
	45 CM	52155-70C	52155-70I		
	24 CM	52224-70C	52224-70I		
 5MM Ø, BIOPSY SPOON FORCEPS, W/ TOOTH (SEMM-TYPE), DBL-ACTION	33 CM	52255-68C	52255-68I	 <u>Type 17:</u> <u>Lightweight Carbon</u> <u>-Fiber w/ RF Post</u>	
	36 CM	52236-68C	52236-68I		
	45 CM	52155-68C	52155-68I		
	24 CM	52224-68C	52224-68I		
 5MM Ø, BIOPSY HOOK PUNCH, SINGLE-ACTION	33 CM	52255-71C	52255-71I	 <u>Type 17:</u> <u>Lightweight Carbon</u> <u>-Fiber w/ RF Post</u>	
	36 CM	52236-71C	52236-71I		
	45 CM	52155-71C	52155-71I		
	24 CM	52224-71C	52224-71I		
 5MM Ø, BIOPSY PUNCH WITH TOOTH, SINGLE-ACTION	33 CM	52255-72C	52255-72I	 <u>Type 17:</u> <u>Lightweight Carbon</u> <u>-Fiber w/ RF Post</u>	
	36 CM	52236-72C	52236-72I		
	45 CM	52155-72C	52155-72I		
	24 CM	52224-72C	52224-72I		
 5MM Ø, BIOPSY PUNCH, SINGLE-ACTION	33 CM	52255-73C	52255-73I	 <u>Type 17:</u> <u>Lightweight Carbon</u> <u>-Fiber w/ RF Post</u>	
	36 CM	52236-73C	52236-73I		
	45 CM	52155-73C	52155-73I		
	24 CM	52224-73C	52224-73I		

TIP & STYLE + HANDLE TYPE = COMPLETE INSTRUMENT
 52255-01B + TYPE 1 = 52255-01B1

This section features our 10mm Rigid One-Piece Instrument (Style A) and our 10mm Rotatable One-Piece Instrument (Style B). Both have flush ports for easy cleaning and are available with any of our suggested handles & any of the handles pictured on Page 28.

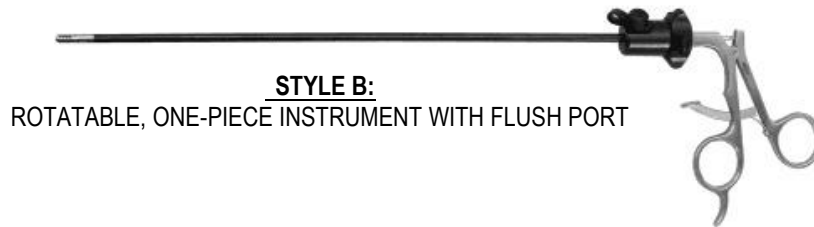
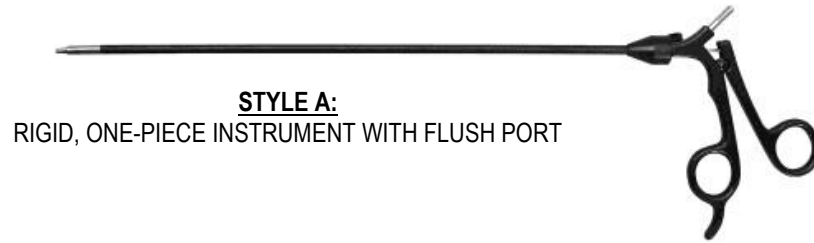

<u>TIP & STYLE</u>	+	<u>HANDLE TYPE</u>	=	<u>COMPLETE INSTRUMENT</u>
52102-01B	+	TYPE 1	=	52102-01B1

GRASPERS & DISSECTORS

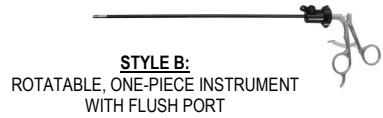
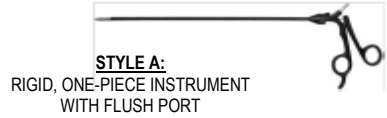

	<u>Length</u>	<u>Style A:</u>	<u>Style B:</u>
10MM, STRONG GRASPER/ DISSECTOR	33 CM	52102-02A	52102-02B
	36 CM	52103-02A	52103-02B
	45 CM	52101-02A	52101-02B
10MM, MARYLAND GRASPER/ DISSECTOR	33 CM	52102-06A	52102-06B
	36 CM	52103-06A	52103-06B
	45 CM	52101-06A	52101-06B
10MM, MIXTER GRASPER/ DISSECTOR, RIGHT ANGLE	33 CM	52102-07A	52102-07B
	36 CM	52103-07A	52103-07B
	45 CM	52101-07A	52101-07B
10MM, MIXTER GRASPER/ DISSECTOR, SHORT RIGHT ANGLE	33 CM	52102-59A	52102-59B
	36 CM	52103-59A	52103-59B
	45 CM	52101-59A	52101-59B
10MM, MIXTER GRASPER/ DISSECTOR, 45° ANGLE	33 CM	52102-08A	52102-08B
	36 CM	52103-08A	52103-08B
	45 CM	52101-08A	52101-08B
10MM, BABCOCK GRASPER, FENESTRATED TIP	33 CM	52102-16A	52102-16B
	36 CM	52103-16A	52103-16B
	45 CM	52101-16A	52101-16B
US BABCOCK GRASPER, SPRING TENSION, ATRAUMATIC	33 CM	52102-17A	52102-17B
	36 CM	52103-17A	52103-17B
	45 CM	52101-17A	52101-17B
10MM, ALLIS GRASPER, FINE AXIAL SERRATIONS	33 CM	52102-21A	52102-21B
	36 CM	52103-21A	52103-21B
	45 CM	52101-21A	52101-21B
10MM, DEBAKEY GRASPER, 40 MM JAW	33 CM	52102-22A	52102-22B
	36 CM	52103-22A	52103-22B
	45 CM	52101-22A	52101-22B
10MM, DEBAKEY GRASPER, 60 MM JAW	33 CM	52102-23A	52102-23B
	36 CM	52103-23A	52103-23B
	45 CM	52101-23A	52101-23B

Recommended

Optional

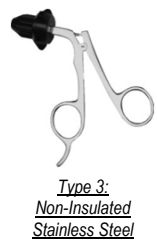

Type 1:
Insulated Stainless
Steel w/ RF Post

Type 3:
Non-Insulated
Stainless Steel

OR



Type 5:
Lightweight Carbon
-Fiber w/ RF Post

Type 7:
Lightweight
Carbon-Fiber w/
RF Post, Ratchet /
Ratchet Defeating

OR



Type 17:
Lightweight Carbon
-Fiber w/ RF Post

Type 9:
Lightweight
Carbon-Fiber w/
RF Post, w/ Large
Finger Loops



Type 18:
Carbon-Fiber w/
RF Post, Ratchet /
Ratchet Defeating

TIP & STYLE + HANDLE TYPE = COMPLETE INSTRUMENT
52255-01B + TYPE 1 = 52255-01B1

GRASPERS & DISSECTORS

STYLE A:
RIGID, ONE-PIECE INSTRUMENT WITH
FLUSH PORT



STYLE B:
ROTATABLE, ONE-PIECE INSTRUMENT
WITH FLUSH PORT



	<u>Length</u>	<u>Style A:</u>	<u>Style B:</u>
10MM, KOCHER GRASPER, 40MM JAW, AXIAL SERRATIONS	33 CM	52102-24A	52102-24B
	36 CM	52103-24A	52103-24B
	45 CM	52101-24A	52101-24B
10MM, KOCHER GRASPER, 60MM JAW, AXIAL SERRATIONS	33 CM	52102-25A	52102-25B
	36 CM	52103-25A	52103-25B
	45 CM	52101-25A	52101-25B
10MM, DUVAL GRASPER, 40MM JAW, AXIAL SERRATIONS	33 CM	52102-26A	52102-26B
	36 CM	52103-26A	52103-26B
	45 CM	52101-26A	52101-26B
10MM, CLAW FORCEPS, 2 X 3 TEETH	33 CM	52102-36A	52102-36B
	36 CM	52103-36A	52103-36B
	45 CM	52101-36A	52101-36B
10MM, SPOON FORCEPS, STANDARD TIP	33 CM	52102-37A	52102-37B
	36 CM	52103-37A	52103-37B
	45 CM	52101-37A	52101-37B
10MM, SPOON FORCEPS, LONG TIP	33 CM	52102-38A	52102-38B
	36 CM	52103-38A	52103-38B
	45 CM	52101-38A	52101-38B
10MM, SCHROEDER TENACULUM FORCEPS, SINGLE TOOTH	33 CM	52102-45A	52102-45B
	36 CM	52103-45A	52103-45B
	45 CM	52101-45A	52101-45B
10MM, SCHROEDER TENACULUM FORCEPS "WISAP STYLE," SINGLE TOOTH W/ EXTRA GUIDE TOOTH	33 CM	52102-94A	52102-94B
	36 CM	52103-94A	52103-94B
	45 CM	52101-94A	52101-94B
10MM, STRONG ATRAUMATIC CLAMP, 40MM STRAIGHT JAW	33 CM	52102-46A	52102-46B
	36 CM	52103-46A	52103-46B
	45 CM	52101-46A	52101-46B
10MM, STRONG ATRAUMATIC CLAMP, 40MM CURVED JAW	33 CM	52102-47A	52102-47B
	36 CM	52136-47A	52136-47B
	45 CM	52101-47A	52101-47B

Recommended

Optional



Type 1:
Insulated Stainless Steel w/ RF Post



Type 3:
Non-Insulated Stainless Steel

OR



Type 5:
Lightweight Carbon-Fiber w/ RF Post



Type 7:
Lightweight Carbon-Fiber w/ RF Post, Ratchet / Ratchet Defeating

OR



Type 9:
Lightweight Carbon-Fiber w/ RF Post, w/ Large Finger Loops



Type 17:
Lightweight Carbon-Fiber w/ RF Post



Type 18:
Carbon-Fiber w/ RF Post, Ratchet / Ratchet Defeating

TIP & STYLE + HANDLE TYPE = COMPLETE INSTRUMENT
52255-01B + TYPE 1 = 52255-01B1

SCISSORS

STYLE A:
RIGID, ONE-PIECE INSTRUMENT WITH
FLUSH PORT



STYLE B:
ROTATABLE, ONE-PIECE INSTRUMENT
WITH FLUSH PORT

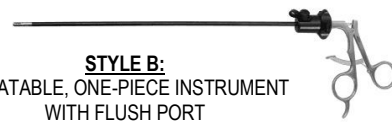

10MM, STRAIGHT SCISSORS,
SINGLE ACTION

10MM, CURVED SCISSORS,
DOUBLE ACTION

<u>Length</u>	<u>Style A:</u>	<u>Style B:</u>
33 CM	52102-64A	52102-64B
36 CM	52136-64A	52136-64B
45 CM	52101-64A	52101-64B

33 CM	52102-67A	52102-67B
36 CM	52136-67A	52136-67B
45 CM	52101-67A	52101-67B

Recommended

Optional



Type 2:
Insulated Stainless
Steel w/ RF Post &
Ratchet



Type 4:
Non-Insulated
Stainless Steel w/
Ratchet

OR



Type 7:
Lightweight
Carbon-Fiber w/
RF Post, Ratchet /
Ratchet Defeating



Type 6:
Lightweight Carbon
-Fiber w/ RF Post
& Ratchet



Type 8:
Lightweight
Carbon-Fiber w/
RF Post, French
On/Off Ratchet

OR



Type 10:
Lightweight
Carbon-Fiber w/
RF Post, Ratchet /
Ratchet Defeating
w/ Large Finger
Loops

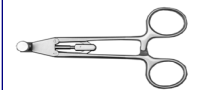

Type 12:
Stainless Steel
Axial Handle w/
Ratchet

TIP & STYLE + HANDLE TYPE = COMPLETE INSTRUMENT
52255-01B + TYPE 1 = 52255-01B1

This section features our 5mm Modular Three-Piece Take Apart instruments, as well as the replacement inserts. Our Three-Piece Modular Instruments are designed to come apart for superior cleaning. They are also completely interchangeable with any of our Laparoscopic Handles found on Page XX, giving Hospitals & Surgery Centers the flexibility to quickly assemble instruments without having to match up every insert, shaft, & handle.

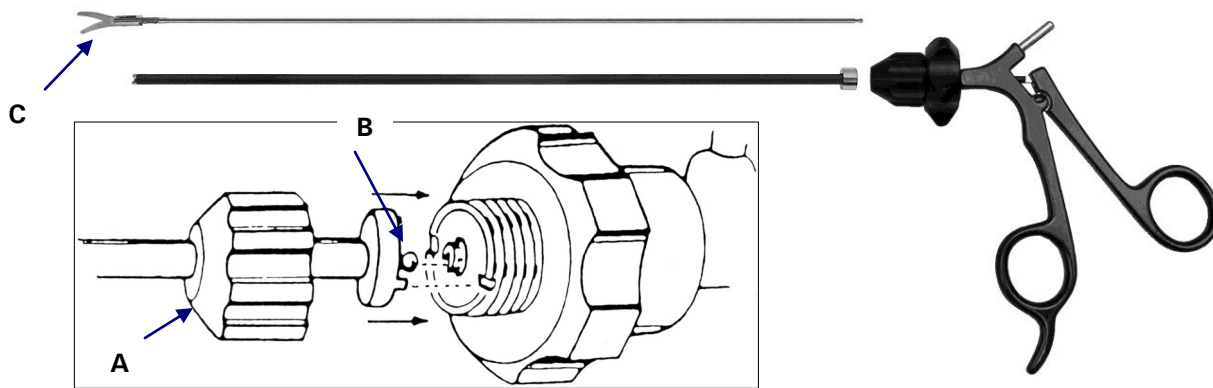

ASSEMBLY:

1. Turn the **Tip (C)** clockwise into the shaft
2. Set the handle in the open position & engage the **Ball (B) of Inner Rod** into its fixation in the handle port.
3. Turn main **Screw Cap (A)** clockwise until it engages the handle.

<u>TIP & STYLE</u>	+	<u>HANDLE TYPE</u>	=	<u>COMPLETE INSTRUMENT</u>
52102-01C	+	TYPE 1	=	52102-01C1

Dissectors & Scissors

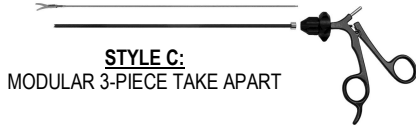

	<u>Length</u>	<u>Style C:</u>	<u>Insert Only::</u>
10MM, STRONG GRASPER/ DISSECTOR	33 CM	52102-02C	52102-02I
	36 CM	52103-02C	52103-02I
	45 CM	52101-02C	52101-02I
10MM, MARYLAND GRASPER/ DISSECTOR	33 CM	52102-06C	52102-06I
	36 CM	52103-06C	52103-06I
	45 CM	52101-06C	52101-06I
10MM, MIXTER GRASPER/ DISSECTOR, RIGHT ANGLE	33 CM	52102-07C	52102-07I
	36 CM	52103-07C	52103-07I
	45 CM	52101-07C	52101-07I
10MM, MIXTER GRASPER/ DISSECTOR, SHORT RIGHT ANGLE	33 CM	52102-59C	52102-59I
	36 CM	52103-59C	52103-59I
	45 CM	52101-59C	52101-59I
10MM, MIXTER GRASPER/ DISSECTOR, 45° ANGLE	33 CM	52102-08C	52102-08I
	36 CM	52103-08C	52103-08I
	45 CM	52101-08C	52101-08I
10MM, BABCOCK GRASPER, FENESTRATED TIP	33 CM	52102-16C	52102-16I
	36 CM	52103-16C	52103-16I
	45 CM	52101-16C	52101-16I
US BABCOCK GRASPER, SPRING TENSION, ATRAUMATIC	33 CM	52102-17C	52102-17I
	36 CM	52103-17C	52103-17I
	45 CM	52101-17C	52101-17I
10MM, ALLIS GRASPER, FINE AXIAL SERRATIONS	33 CM	52102-21C	52102-21I
	36 CM	52103-21C	52103-21I
	45 CM	52101-21C	52101-21I
10MM, DEBAKEY GRASPER, 40 MM JAW	33 CM	52102-22C	52102-22I
	36 CM	52103-22C	52103-22I
	45 CM	52101-22C	52101-22I
10MM, DEBAKEY GRASPER, 60 MM JAW	33 CM	52102-23C	52102-23I
	36 CM	52103-23C	52103-23I
	45 CM	52101-23C	52101-23I

Recommended

Optional



Type 1:
Insulated Stainless
Steel w/ RF Post

Type 3:
Non-Insulated
Stainless Steel

OR



Type 7:
Lightweight
Carbon-Fiber w/
RF Post, Ratchet /
Ratchet Defeating

Type 5:
Lightweight Carbon
-Fiber w/ RF Post



OR



Type 17:
Lightweight Carbon
-Fiber w/ RF Post

Type 18:
Carbon-Fiber w/
RF Post, Ratchet /
Ratchet Defeating

TIP & STYLE + HANDLE TYPE = COMPLETE INSTRUMENT
 52255-01B + TYPE 1 = 52255-01B1

GRASPERS & DISSECTORS

STYLE C:
MODULAR 3-PIECE TAKE APART

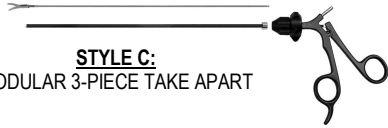

INSERT ONLY:



	<u>Length</u>	<u>Style C:</u>	<u>Insert Only::</u>
10MM, KOCHER GRASPER, 40MM JAW, AXIAL SERRATIONS	33 CM	52102-24C	52102-24I
	36 CM	52103-24C	52103-24I
	45 CM	52101-24C	52101-24I
10MM, KOCHER GRASPER, 60MM JAW, AXIAL SERRATIONS	33 CM	52102-25C	52102-25I
	36 CM	52103-25C	52103-25I
	45 CM	52101-25C	52101-25I
10MM, DUVAL GRASPER, 40MM JAW, AXIAL SERRATIONS	33 CM	52102-26C	52102-26I
	36 CM	52103-26C	52103-26I
	45 CM	52101-26C	52101-26I
10MM, CLAW FORCEPS, 2 X 3 TEETH	33 CM	52102-36C	52102-36I
	36 CM	52103-36C	52103-36I
	45 CM	52101-36C	52101-36I
10MM, SPOON FORCEPS, STANDARD TIP	33 CM	52102-37C	52102-37I
	36 CM	52103-37C	52103-37I
	45 CM	52101-37C	52101-37I
10MM, SPOON FORCEPS, LONG TIP	33 CM	52102-38C	52102-38I
	36 CM	52103-38C	52103-38I
	45 CM	52101-38C	52101-38I
10MM, SCHROEDER TENACULUM FORCEPS, SINGLE TOOTH	33 CM	52102-45C	52102-45I
	36 CM	52103-45C	52103-45I
	45 CM	52101-45C	52101-45I
10MM, SCHROEDER TENACULUM FORCEPS "WISAP STYLE," SINGLE TOOTH W/ EXTRA GUIDE TOOTH	33 CM	52102-94C	52102-94I
	36 CM	52103-94C	52103-94I
	45 CM	52101-94C	52101-94I
10MM, STRONG ATRAUMATIC CLAMP, 40MM STRAIGHT JAW	33 CM	52102-46C	52102-46I
	36 CM	52103-46C	52103-46I
	45 CM	52101-46C	52101-46I
10MM, STRONG ATRAUMATIC CLAMP, 40MM CURVED JAW	33 CM	52102-47C	52102-47I
	36 CM	52136-47C	52136-47I
	45 CM	52101-47C	52101-47I

Recommended

Optional



Type 1:
Insulated Stainless Steel w/ RF Post

Type 3:
Non-Insulated Stainless Steel

OR



Type 7:
Lightweight Carbon-Fiber w/ RF Post, Ratchet / Ratchet Defeating

Type 5:
Lightweight Carbon-Fiber w/ RF Post



OR

Type 9:
Lightweight Carbon-Fiber w/ RF Post, w/ Large Finger Loops



Type 17:
Lightweight Carbon-Fiber w/ RF Post

Type 18:
Carbon-Fiber w/ RF Post, Ratchet / Ratchet Defeating

TIP & STYLE + HANDLE TYPE = COMPLETE INSTRUMENT
52255-01B + TYPE 1 = 52255-01B1

SCISSORS

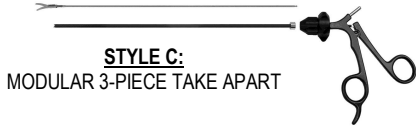

10MM, STRAIGHT SCISSORS,
SINGLE ACTION

10MM, CURVED SCISSORS,
DOUBLE ACTION

<u>Length</u>	<u>Style C:</u>	<u>Insert Only::</u>
33 CM	52102-64C	52102-64I
36 CM	52136-64C	52136-64I
45 CM	52101-64C	52101-64I

33 CM	52102-67C	52102-67I
36 CM	52136-67C	52136-67I
45 CM	52101-67C	52101-67I

Recommended

Optional



Type 2:
Insulated Stainless
Steel w/ RF Post &
Ratchet



Type 4:
Non-Insulated
Stainless Steel w/
Ratchet

OR



Type 6:
Lightweight Carbon
-Fiber w/ RF Post
& Ratchet



Type 7:
Lightweight
Carbon-Fiber w/
RF Post, Ratchet /
Ratchet Defeating

OR



Type 10:
Lightweight
Carbon-Fiber w/
RF Post, Ratchet /
Ratchet Defeating
w/ Large Finger
Loops



Type 8:
Lightweight
Carbon-Fiber w/
RF Post, French
On/Off Ratchet

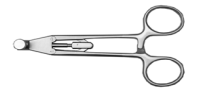

Type 12:
Stainless Steel
Axial Handle w/
Ratchet

TIP & STYLE + HANDLE TYPE = COMPLETE INSTRUMENT
52255-01B + TYPE 1 = 52255-01B1

OPTIONAL HANDLES FOR ANY OF OUR "BLUE MONARCH" INSTRUMENTS



TYPE 1:
INSULATED WITH RF-
POST



TYPE 2:
INSULATED W/ RF-
POST & RATCHET



TYPE 3:
NON-INSULATED
STAINLESS STEEL



TYPE 4:
NON-INSULATED
STAINLESS STEEL W/
RATCHET



TYPE 5:
LIGHTWEIGHT
CARBON-FIBER W/ RF
POST



TYPE 6:
LIGHTWEIGHT
CARBON-FIBER
w/ RF-POST &
RATCHET



TYPE 7:
LIGHTWEIGHT
CARBON-FIBER
W/ RF POST,
RATCHET /
RATCHET
DEFEATING



TYPE 8:
LIGHTWEIGHT CARBON
-FIBER W/ RF POST,
FRENCH ON/OFF
RATCHET



TYPE 9:
LIGHTWEIGHT
CARBON-FIBER W/ RF
POST, W/ LARGE
FINGER LOOPS



TYPE 10:
LIGHTWEIGHT
CARBON-FIBER W/ RF
POST, RATCHET /
RATCHET DEFEATING
W/ LARGE FINGER
LOOPS

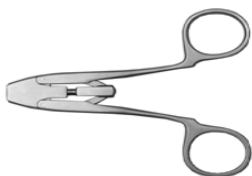

TYPE 11:
STAINLESS STEEL RING
AXIAL HANDLE



TYPE 12:
STAINLESS STEEL RING AXIAL
HANDLE W/ RATCHET



TYPE 13:
STAINLESS STEEL AXIAL HANDLE
w/ PRECISE ENGAGEMENT
RATCHET



TYPE 14:
INSULATED STAINLESS
STEEL LINVATEC-WECK
STYLE W/ LONG
SHANKS



TYPE 15:
NON-INSULATED
STAINLESS STEEL
LINVATEC-WECK STYLE
W/ QUICK RELEASE
RATCHET & LONG
SHANKS



TYPE 16:
NON-INSULATED
STAINLESS STEEL W/
SPRING ASSIST
CLOSING



TYPE 18:
CARBON-FIBER W/ RF
POST











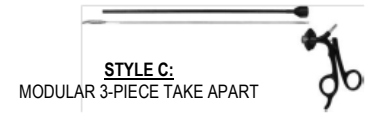
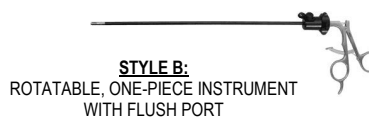
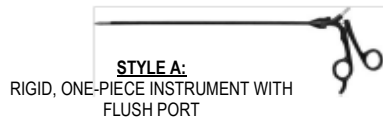

TYPE 18:
CARBON-FIBER W/ RF
POST, RATCHET /
RATCHET DEFEATING

5MM SURE-GRIP SLIDE-LOCK HANDLE GRASPERS

Features of the Slide-Lock Grasper:

- Slide-lock handle with on or off position for sure-grip grasping retention
- Single & double action atraumatic and retraction jaw patterns
- Rotatable & rigid one piece instruments w/ flush ports for optimal cleaning and modular 3-piece take-apart for maximum cleaning
- Constructed of the highest grade medical stainless steel, medical-grade polymer coating & plastics
- Completely reusable and fully autoclavable



	Length	Style A:	Style B:	Style C:
 STANDARD GRASPER W/ SPOON, DOUBLE-ACTION, STRAIGHT SERRATED JAWS W/ PROXIMAL RECESS SPOON, DOUBLE-ACTION, INSULATED SHAFT	33 CM	52605-02A	52605-02B	52605-02C
	36 CM	52636-02A	52636-02B	52636-02C
	45 CM	52615-02A	52615-02B	52615-02C
	24 CM	52624-02A	52624-02B	52624-02C
 STANDARD GRASPER W/SERRATED JAWS FOR MAX GRIP, DOUBLE-ACTION, INSULATED SHAFT	33 CM	52605-03A	52605-03B	52605-03C
	36 CM	52636-03A	52636-03B	52636-03C
	45 CM	52615-03A	52615-03B	52615-03C
	24 CM	52624-03A	52624-03B	52624-03C
 5MM Ø, TAPERED DOLPHIN-NOSE GRASPER/DISSECTOR	33 CM	52605-04A	52605-04B	52605-04C
	36 CM	52636-04A	52636-04B	52636-04C
	45 CM	52615-04A	52615-04B	52615-04C
	24 CM	52624-04A	52624-04B	52624-04C
 5MM Ø, TAPERED DOLPHIN-NOSE GRASPER/DISSECTOR W/ SPOON	33 CM	52605-104A	52605-104B	52605-104C
	36 CM	52636-104A	52636-104B	52636-104C
	45 CM	52615-104A	52615-104B	52615-104C
	24 CM	52624-104A	52624-104B	52624-104C
 5MM Ø, COBRA GRASPER, DOUBLE-ACTION	33 CM	52605-15A	52605-15B	52605-15C
	36 CM	52636-15A	52636-15B	52636-15C
	45 CM	52615-15A	52615-15B	52615-15C
	24 CM	52624-15A	52624-15B	52624-15C
 BABCOCK GRASPER W/ FENESTRATED TIP, TRADITIONAL DESIGN FOR GRASPING DELICATE TISSUE, DOUBLE-ACTION, INSULATED SHAFT	33 CM	52605-16A	52605-16B	52605-16C
	36 CM	52636-16A	52636-16B	52636-16C
	45 CM	52615-16A	52615-16B	52615-16C
	24 CM	52624-16A	52624-16B	52624-16C
 5MM Ø, BABCOCK GRASPER, AXIS STYLE, FENESTRATED TIP	33 CM	52605-116A	52605-116B	52605-116C
	36 CM	52636-116A	52636-116B	52636-116C
	45 CM	52615-116A	52615-116B	52615-116C
	24 CM	52624-116A	52624-116B	52624-116C
 5MM Ø, BABCOCK GRASPER-SHORT: DELICATE APPLICATION	33 CM	52605-17A	52605-17B	52605-17C
	36 CM	52636-17A	52636-17B	52636-17C
	45 CM	52615-17A	52615-17B	52615-17C
	24 CM	52624-17A	52624-17B	52624-17C
 5MM Ø, ALLIS GRASPER, SHORT VERSION, SINGLE ACTION	33 CM	52605-18A	52605-18B	52605-18C
	36 CM	52636-18A	52636-18B	52636-18C
	45 CM	52615-18A	52615-18B	52615-18C
	24 CM	52624-18A	52624-18B	52624-18C
 5MM Ø, ALLIS GRASPER, SHORT VERSION, 3 X 4 TEETH, SERRATED, DOUBLE-ACTION	33 CM	52605-19A	52605-19B	52605-19C
	36 CM	52636-19A	52636-19B	52636-19C
	45 CM	52615-19A	52615-19B	52615-19C
	24 CM	52624-19A	52624-19B	52624-19C

5MM SURE-GRIP SLIDE-LOCK HANDLE GRASPERS

Features of the Slide-Lock Grasper:

- Slide-lock handle with on or off position for sure-grip grasping retention
- Single & double action atraumatic and retraction jaw patterns
- Rotatable & rigid one piece instruments w/ flush ports for optimal cleaning and modular 3-piece take-apart for maximum cleaning
- Constructed of the highest grade medical stainless steel, medical-grade polymer coating & plastics
- Completely reusable and fully autoclavable



STYLE A:
RIGID, ONE-PIECE INSTRUMENT WITH FLUSH PORT



STYLE B:
ROTATABLE, ONE-PIECE INSTRUMENT WITH FLUSH PORT



STYLE C:
MODULAR 3-PIECE TAKE APART











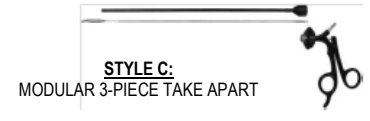
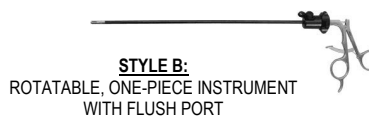
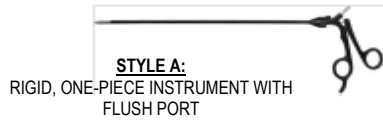

5MM Ø, ATRAUMATIC ALLIS GRASPER, SHORT VERSION, SERRATED W/ DOUBLE ROW OF TEETH, DOUBLE-ACTION	33 CM	52605-119A	52605-119B	52605-119C
	36 CM	52636-119A	52636-119B	52636-119C
	45 CM	52615-119A	52615-119B	52615-119C
	24 CM	52624-119A	52624-119B	52624-119C
5MM Ø, ATRAUMATIC ALLIS GRASPER, LONG VERSION, SERRATED W/ DOUBLE ROW OF TEETH, DOUBLE-ACTION	33 CM	52605-219A	52605-219B	52605-219C
	36 CM	52636-219A	52636-219B	52636-219C
	45 CM	52615-219A	52615-219B	52615-219C
	24 CM	52624-219A	52624-219B	52624-219C
ALLIS GRASPER, MEDIUM VERSION, UNIQUE TEETH DESIGN FOR ATRAUMATIC STRONG HOLD, DOUBLE-ACTION, INSULATED SHAFT	33 CM	52605-20A	52605-20B	52605-20C
	36 CM	52636-20A	52636-20B	52636-20C
	45 CM	52615-20A	52615-20B	52615-20C
	24 CM	52624-20A	52624-20B	52624-20C
ALLIS GRASPER, STANDARD VERSION, LONG UNIQUE TEETH DESIGN FOR ATRAUMATIC STRONG HOLD, DOUBLE-ACTION, INSULATED SHAFT STANDARD GRASPER W/SERRATED JAWS FOR MAX GRIP, DOUBLE-ACTION, INSULATED SHAFT	33 CM	52605-21A	52605-21B	52605-21C
	36 CM	52636-21A	52636-21B	52636-21C
	45 CM	52615-21A	52615-21B	52615-21C
	24 CM	52624-21A	52624-21B	52624-21C
DEBAKEY GRASPER, 20MM LONG JAW, TRADITIONAL DEBAKEY-TYPE TEETH FOR PRECISE ATRAUMATIC GRASPING, DOUBLE-ACTION, INSULATED SHAFT	33 CM	52605-22A	52605-22B	52605-22C
	36 CM	52636-22A	52636-22B	52636-22C
	45 CM	52615-22A	52615-22B	52615-22C
	24 CM	52624-22A	52624-22B	52624-22C
DEBAKEY GRASPER, 40MM LONG JAW, TRADITIONAL DEBAKEY-TYPE TEETH FOR PRECISE ATRAUMATIC GRASPING, DOUBLE-ACTION, INSULATED SHAFT	33 CM	52605-23A	52605-23B	52605-23C
	36 CM	52636-23A	52636-23B	52636-23C
	45 CM	52615-23A	52615-23B	52615-23C
	24 CM	52624-23A	52624-23B	52624-23C
DEBAKEY GRASPER, 60MM LONG JAW, TRADITIONAL DEBAKEY-TYPE TEETH FOR PRECISE ATRAUMATIC GRASPING, DOUBLE-ACTION, INSULATED SHAFT	33 CM	52605-124A	52605-124B	52605-124C
	36 CM	52636-124A	52636-124B	52636-124C
	45 CM	52615-124A	52615-124B	52615-124C
	24 CM	52624-124A	52624-124B	52624-124C
5MM Ø, GLASSMAN ATRAUMATIC GRASPER	33 CM	52605-24A	52605-24B	52605-24C
	36 CM	52636-24A	52636-24B	52636-24C
	45 CM	52615-24A	52615-24B	52615-24C
	24 CM	52624-24A	52624-24B	52624-24C
DOUBLE-CUP FUNDUS MAXI GRASPER, DOUBLE CUP DESIGN INCREASES SURFACE AREA CONTENT IMPROVING TISSUE HOLD, DOUBLE-ACTION, INSULATED SHAFT	33 CM	52605-26A	52605-26B	52605-26C
	36 CM	52636-26A	52636-26B	52636-26C
	45 CM	52615-26A	52615-26B	52615-26C
	24 CM	52624-26A	52624-26B	52624-26C
ENDO CLINCH FENESTRATED GRASPER, LONG FENESTRATED JAW WITH INTERLOCKING WAVE-LIKE TEETH FOR STRONG HOLD, DOUBLE-ACTION, INSULATED SHAFT	33 CM	52605-27A	52605-27B	52605-27C
	36 CM	52636-27A	52636-27B	52636-27C
	45 CM	52615-27A	52615-27B	52615-27C
	24 CM	52624-27A	52624-27B	52624-27C

5MM SURE-GRIP SLIDE-LOCK HANDLE GRASPERS

Features of the Slide-Lock Grasper:

- Slide-lock handle with on or off position for sure-grip grasping retention
- Single & double action atraumatic and retraction jaw patterns
- Rotatable & rigid one piece instruments w/ flush ports for optimal cleaning and modular 3-piece take-apart for maximum cleaning
- Constructed of the highest grade medical stainless steel, medical-grade polymer coating & plastics
- Completely reusable and fully autoclavable











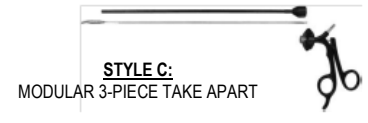
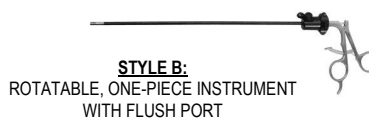
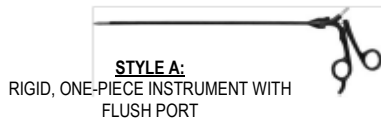

	Length	Style A:	Style B:	Style C:
 <p>RETRO-FACING RAT TOOTH GRASPER W/ ATRAUMATIC CUP, ATRAUMATIC STRONG GRASPER, DOUBLE-ACTION, INSULATED SHAFT</p>	33 CM	52605-28A	52605-28B	52605-28C
	36 CM	52636-28A	52636-28B	52636-28C
	45 CM	52615-28A	52615-28B	52615-28C
	24 CM	52624-28A	52624-28B	52624-28C
 <p>WAVE FUNDUS GRASPER, LONG BEVELED EDGE JAWS, FOR LARGE GRASP ON TISSUE, DOUBLE-ACTION, INSULATED SHAFT</p>	33 CM	52605-32A	52605-32B	52605-32C
	36 CM	52636-32A	52636-32B	52636-32C
	45 CM	52615-32A	52615-32B	52615-32C
	24 CM	52624-32A	52624-32B	52624-32C
 <p>WAVE FUNDUS GRASPER, LONG BEVELED EDGE JAWS, FOR LARGE GRASP ON TISSUE, SINGLE-ACTION, INSULATED SHAFT</p>	33 CM	52605-33A	52605-33B	52605-33C
	36 CM	52636-33A	52636-33B	52636-33C
	45 CM	52615-33A	52615-33B	52615-33C
	24 CM	52624-33A	52624-33B	52624-33C
 <p>5MM Ø, RETRACTION GRASPER, LONG RIDGED JAWS, 2 X 3 ATRAUMATIC TEETH, DOUBLE-ACTION</p>	33 CM	52605-34A	52605-34B	52605-34C
	36 CM	52636-34A	52636-34B	52636-34C
	45 CM	52615-34A	52615-34B	52615-34C
	24 CM	52624-34A	52624-34B	52624-34C
 <p>RETRACTION GRASPER, AGGRESSIVE 2X3 TEETH W/ ATRAUMATIC LONG RIDGED JAW FOR STRONG PRECISE GRIP, SINGLE-ACTION, INSULATED SHAFT</p>	33 CM	52605-35A	52605-35B	52605-35C
	36 CM	52636-35A	52636-35B	52636-35C
	45 CM	52615-35A	52615-35B	52615-35C
	24 CM	52624-35A	52624-35B	52624-35C
 <p>RETRACTION GRASPER, AGGRESSIVE 2X3 TEETH W/ ATRAUMATIC LONG RIDGED JAW FOR STRONG PRECISE GRIP, DBL-ACTION, INSULATED SHAFT (JARIT STYLE)</p>	33 CM	52605-134A	52605-134B	52605-134C
	36 CM	52636-134A	52636-134B	52636-134C
	45 CM	52615-134A	52615-134B	52615-134C
	24 CM	52624-134A	52624-134B	52624-134C
 <p>RETRACTION GRASPER, AGGRESSIVE 2X3 TEETH W/ ATRAUMATIC LONG RIDGED JAW FOR STRONG PRECISE GRIP, SINGLE-ACTION, INSULATED SHAFT (JARIT STYLE)</p>	33 CM	52605-135A	52605-135B	52605-135C
	36 CM	52636-135A	52636-135B	52636-135C
	45 CM	52615-135A	52615-135B	52615-135C
	24 CM	52624-135A	52624-135B	52624-135C
 <p>FENESTRATED GRASPER, 22 MM, STRAIGHT SERRATED JAWS W/ LONG FENESTRATION FOR ATRAUMATIC GRIP, DOUBLE-ACTION, INSULATED SHAFT</p>	33 CM	52605-39A	52605-39B	52605-39C
	36 CM	52636-39A	52636-39B	52636-39C
	45 CM	52615-39A	52615-39B	52615-39C
	24 CM	52624-39A	52624-39B	52624-39C
 <p>FENESTRATED GRASPER, 40 MM, STRAIGHT SERRATED JAWS W/ LONG FENESTRATION FOR ATRAUMATIC GRIP, DOUBLE-ACTION, INSULATED SHAFT</p>	33 CM	52605-40A	52605-40B	52605-40C
	36 CM	52636-40A	52636-40B	52636-40C
	45 CM	52615-40A	52615-40B	52615-40C
	24 CM	52624-40A	52624-40B	52624-40C
 <p>FENESTRATED GRASPER, 22 MM, STRAIGHT SERRATED JAWS W/ LONG FENESTRATION FOR ATRAUMATIC GRIP, SINGLE-ACTION, INSULATED SHAFT</p>	33 CM	52605-41A	52605-41B	52605-41C
	36 CM	52636-41A	52636-41B	52636-41C
	45 CM	52615-41A	52615-41B	52615-41C
	24 CM	52624-41A	52624-41B	52624-41C

5MM SURE-GRIP SLIDE-LOCK HANDLE GRASPERS

Features of the Slide-Lock Grasper:

- Slide-lock handle with on or off position for sure-grip grasping retention
- Single & double action atraumatic and retraction jaw patterns
- Rotatable & rigid one piece instruments w/ flush ports for optimal cleaning and modular 3-piece take-apart for maximum cleaning
- Constructed of the highest grade medical stainless steel, medical-grade polymer coating & plastics
- Completely reusable and fully autoclavable



	Length	Style A:	Style B:	Style C:
 FENESTRATED GRASPER, 40 MM, STRAIGHT SERRATED JAWS W/ LONG FENESTRATION FOR ATRAUMATIC GRIP, SINGLE-ACTION, INSULATED SHAFT	33 CM	52605-42A	52605-42B	52605-42C
	36 CM	52636-42A	52636-42B	52636-42C
	45 CM	52615-42A	52615-42B	52615-42C
	24 CM	52624-42A	52624-42B	52624-42C
 SCHROEDER TENACULUM GRASPER, SINGE-TOOTH LONG JAW FOR MAXIMUM GRASP OF THICK TISSUE, DOUBLE-ACTION, INSULATED SHAFT	33 CM	52605-45A	52605-45B	52605-45C
	36 CM	52636-45A	52636-45B	52636-45C
	45 CM	52615-45A	52615-45B	52615-45C
	24 CM	52624-45A	52624-45B	52624-45C
 DEBAKEY CURVED GRASPER W/ ATRAUMATIC TEETH, FOR PRECISE ATRAUMATIC GRIP, DOUBLE-ACTION, INSULATED SHAFT	33 CM	52605-46A	52605-46B	52605-46C
	36 CM	52636-46A	52636-46B	52636-46C
	45 CM	52615-46A	52615-46B	52615-46C
	24 CM	52624-46A	52624-46B	52624-46C
 HUNTER BOWEL GRASPER, 22 MM JAW, FENESTRATED JAW W/ DEBAKEY-TYPE TEETH FOR ATRAUMATIC MANIPULATION OF DELICATE TISSUE E.G. BOWEL, STOMACH; DOUBLE-ACTION, INSULATED SHAFT	33 CM	52605-58A	52605-58B	52605-58C
	36 CM	52636-58A	52636-58B	52636-58C
	45 CM	52615-58A	52615-58B	52615-58C
	24 CM	52624-58A	52624-58B	52624-58C
 HUNTER BOWEL GRASPER, 40 MM JAW, FENESTRATED JAW W/ DEBAKEY-TYPE TEETH FOR ATRAUMATIC MANIPULATION OF DELICATE TISSUE E.G. BOWEL, STOMACH; DBL-ACTION, INSULATED SHAFT	33 CM	52605-159A	52605-159B	52605-159C
	36 CM	52636-159A	52636-159B	52636-159C
	45 CM	52615-159A	52615-159B	52615-159C
	24 CM	52624-159A	52624-159B	52624-159C
 HUNTER BOWEL GRASPER, 60 MM JAW, FENESTRATED JAW W/ DEBAKEY-TYPE TEETH FOR ATRAUMATIC MANIPULATION OF DELICATE TISSUE E.G. BOWEL, STOMACH; DBL-ACTION, INSULATED SHAFT	33 CM	52605-160A	52605-160B	52605-160C
	36 CM	52636-160A	52636-160B	52636-160C
	45 CM	52615-160A	52615-160B	52615-160C
	24 CM	52624-160A	52624-160B	52624-160C
 THE POPULAR "DAVOL" TYPE, ATRAUMATIC GRASPER, SCOOPED-OUT JAW & GENTLY MASHING TEETH, EASY ON TISSUE & EXCELLENT HOLDING; DOUBLE-ACTION, INSULATED SHAFT	33 CM	52605-90A	52605-90B	52605-90C
	36 CM	52636-90A	52636-90B	52636-90C
	45 CM	52615-90A	52615-90B	52615-90C
	24 CM	52624-90A	52624-90B	52624-90C
 5MM Ø, "ACCESS" TYPE, FENESTRATED GRASPER, 20MM JAW W/ AGGRESSIVE TEETH FOR POSITIVE EXTRA STRONG TISSUE HOLDING	33 CM	52605-91A	52605-91B	52605-91C
	36 CM	52636-91A	52636-91B	52636-91C
	45 CM	52615-91A	52615-91B	52615-91C
	24 CM	52624-91A	52624-91B	52624-91C
 "SOFT TOUCH" GRASPER, 22 MM JAW, ATRAUMATIC TEFLON INSERTS FOR THE LIGHT MINIMUM TISSUE TRAUMA TOUCH YET W/ POSITIVE HOLDING; DOUBLE-ACTION, INSULATED SHAFT	33 CM	52605-92A	52605-92B	52605-92C
	36 CM	52636-92A	52636-92B	52636-92C
	45 CM	52615-92A	52615-92B	52615-92C
	24 CM	52624-92A	52624-92B	52624-92C
 "SOFT TOUCH" GRASPER 40 MM JAW, ATRAUMATIC TEFLON INSERTS FOR THE LIGHT MINIMUM TISSUE TRAUMA TOUCH YET W/ POSITIVE HOLDING; DOUBLE-ACTION, INSULATED SHAFT	33 CM	52605-93A	52605-93B	52605-93C
	36 CM	52636-93A	52636-93B	52636-93C
	45 CM	52615-93A	52615-93B	52615-93C
	24 CM	52624-93A	52624-93B	52624-93C

10MM SURE-GRIP SLIDE-LOCK HANDLE GRASPERS

Features of the Slide-Lock Grasper:

- Slide-lock handle with on or off position for sure-grip grasping retention
- Single & double action atraumatic and retraction jaw patterns
- Rotatable & rigid one piece instruments w/ flush ports for optimal cleaning and modular 3-piece take-apart for maximum cleaning
- Constructed of the highest grade medical stainless steel, medical-grade polymer coating & plastics
- Completely reusable and fully autoclavable

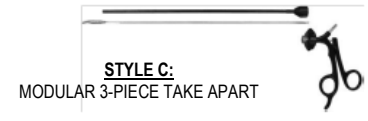
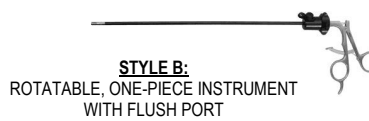
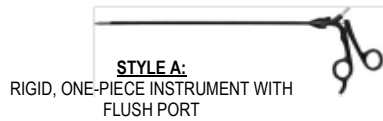

	Length	Style A:	Style B:	Style C:	
	STANDARD GRASPER W/ SPOON, DOUBLE-ACTION, STRAIGHT SERRATED JAWS W/ PROXIMAL RECESS SPOON, DOUBLE-ACTION, INSULATED SHAFT	33 CM	52610-02A	52610-02B	52610-02C
	36 CM	52612-02A	52612-02B	52612-02C	
	45 CM	52611-02A	52611-02B	52611-02C	
	STANDARD GRASPER W/SERRATED JAWS FOR MAX GRIP, DOUBLE-ACTION, INSULATED SHAFT	33 CM	52610-03A	52610-03B	52610-03C
	36 CM	52612-03A	52612-03B	52612-03C	
	45 CM	52611-03A	52611-03B	52611-03C	
	BABCOCK GRASPER W/ FENESTRATED TIP, TRADITIONAL DESIGN FOR GRASPING DELICATE TISSUE, DOUBLE-ACTION, INSULATED SHAFT	33 CM	52610-16A	52610-16B	52610-16C
	36 CM	52612-16A	52612-16B	52612-16C	
	45 CM	52611-16A	52611-16B	52611-16C	
	ALLIS GRASPER, MEDIUM VERSION, UNIQUE TEETH DESIGN FOR ATRAUMATIC STRONG HOLD, DOUBLE-ACTION, INSULATED SHAFT	33 CM	52610-20A	52610-20B	52610-20C
	36 CM	52612-20A	52612-20B	52612-20C	
	45 CM	52611-20A	52611-20B	52611-20C	
	ALLIS GRASPER, STANDARD VERSION, LONG UNIQUE TEETH DESIGN FOR ATRAUMATIC STRONG HOLD, DOUBLE-ACTION, INSULATED SHAFT STANDARD GRASPER W/SERRATED JAWS FOR MAX GRIP, DOUBLE-ACTION, INSULATED SHAFT	33 CM	52610-21A	52610-21B	52610-21C
	36 CM	52612-21A	52612-21B	52612-21C	
	45 CM	52611-21A	52611-21B	52611-21C	
	DEBAKEY GRASPER, 20MM LONG JAW, TRADITIONAL DEBAKEY-TYPE TEETH FOR PRECISE ATRAUMATIC GRASPING, DOUBLE-ACTION, INSULATED SHAFT	33 CM	52610-22A	52610-22B	52610-22C
	36 CM	52612-22A	52612-22B	52612-22C	
	45 CM	52611-22A	52611-22B	52611-22C	
	DEBAKEY GRASPER, 40MM LONG JAW, TRADITIONAL DEBAKEY-TYPE TEETH FOR PRECISE ATRAUMATIC GRASPING, DOUBLE-ACTION, INSULATED SHAFT	33 CM	52610-23A	52610-23B	52610-23C
	36 CM	52612-23A	52612-23B	52612-23C	
	45 CM	52611-23A	52611-23B	52611-23C	
	DEBAKEY GRASPER, 60MM LONG JAW, TRADITIONAL DEBAKEY-TYPE TEETH FOR PRECISE ATRAUMATIC GRASPING, DOUBLE-ACTION, INSULATED SHAFT	33 CM	52610-124A	52610-124B	52610-124C
	36 CM	52612-124A	52612-124B	52612-124C	
	45 CM	52611-124A	52611-124B	52611-124C	
	DOUBLE-CUP FUNDUS MAXI GRASPER, DOUBLE CUP DESIGN INCREASES SURFACE AREA CONTENT IMPROVING TISSUE HOLD, DOUBLE-ACTION, INSULATED SHAFT	33 CM	52610-26A	52610-26B	52610-26C
	36 CM	52612-26A	52612-26B	52612-26C	
	45 CM	52611-26A	52611-26B	52611-26C	
	ENDO CLINCH FENESTRATED GRASPER, LONG FENESTRATED JAW WITH INTERLOCKING WAVE-LIKE TEETH FOR STRONG HOLD, DOUBLE-ACTION, INSULATED SHAFT	33 CM	52610-27A	52610-27B	52610-27C
	36 CM	52612-27A	52612-27B	52612-27C	
	45 CM	52611-27A	52611-27B	52611-27C	